

Panasonic Telephone Systems



www.voicesonic.com

Phone 877-289-2829

KX-TDA5480
KX-TDA0484

4-Channel VoIP Gateway Card **Programming Guide**

Panasonic KX-TDA5480, KXTDA5480, TDA5480, KX-TDA0484, KXTDA0484, TDA0484



Thank you for purchasing a Panasonic 4-Channel VoIP Gateway Card.
Please read this manual carefully before using this product and save this manual for future use.

Table of Contents

1	IP-GW4 Maintenance Utility	3
1.1	Starting the IP-GW4 Maintenance Utility	4
2	Administrator Functions	7
2.1	Main Menu for the Administrator	8
2.2	Programming	10
2.2.1	Network Parameters	10
2.2.2	H.323 Parameters	14
2.2.3	Voice Communication Parameters	18
2.2.4	VoIP Gateway/IP-PBX Interface Parameters	25
2.2.5	Hunt Pattern Parameters	27
2.2.6	Address Translation Table—GW Entry	32
2.2.7	Address Translation Table—DN2IP Entry	35
2.2.8	Initialization	39
2.3	Maintenance	40
2.3.1	Status Control	40
2.3.2	Maintenance Settings	41
2.3.3	Diagnosis	43
2.3.4	Log Information	44
2.4	Data Management	45
2.4.1	Upload of Configuration Data	45
2.4.2	Download of Configuration Data	47
2.4.3	Upload of Address Translation Table	48
2.4.4	Download of Address Translation Table	50
2.5	Others	51
2.5.1	Reboot	51
2.5.2	Log Out	52
3	Installer Functions	53
3.1	Main Menu for the Installer	54
3.2	Maintenance	55
3.2.1	Status Control	55
3.2.2	Maintenance Settings	56
3.3	Data Management	58
3.3.1	Upload of Firmware Data	58
3.3.2	Handling of Firmware Page	61
3.4	Others	63
3.4.1	Reboot	63
3.4.2	Log Out	64
Index		65

Section 1

IP-GW4 Maintenance Utility

Programming of the VoIP Gateway Card is carried out through a web programming utility called the IP-GW4 Maintenance Utility. This section provides the start-up procedure for the IP-GW4 Maintenance Utility.

1.1 Starting the IP-GW4 Maintenance Utility

There are 2 different log-in levels to the IP-GW4 Maintenance Utility, a web programming utility for the VoIP Gateway Card: Administrator level and Installer level. These levels provide different programming options.

For full discussions of Administrator-level programming and Installer-level programming, refer to "2 Administrator Functions" and "3 Installer Functions", respectively.

System Requirements

- The IP-GW4 Maintenance Utility requires Microsoft® Internet Explorer 5.0 or above.

Trademarks

- Microsoft is either a registered trademark or trademark of Microsoft Corporation in the United States and/or other countries.
- All other trademarks identified herein are the property of their respective owners.
- Screen shots reprinted with permission from Microsoft Corporation.

1. Run Internet Explorer from the **Start** menu.
2. In the **Address** box of Internet Explorer, type **http://192.168.1.200**.
192.168.1.200 is the default IP address of the VoIP Gateway Card.

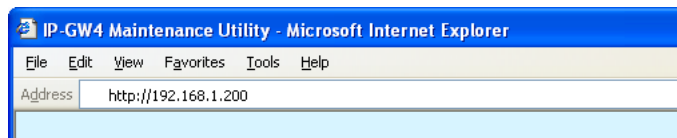

3. Press the ENTER key on the keyboard.
4. In the **Username** box, type the user name.
 - Default Administrator-level user name: **Administrator**
 - Default Installer-level user name: **Installer**
5. In the **Password** box, type the password.
 - Default Administrator-level password: **Administrator**
 - Default Installer-level password: **Installer**

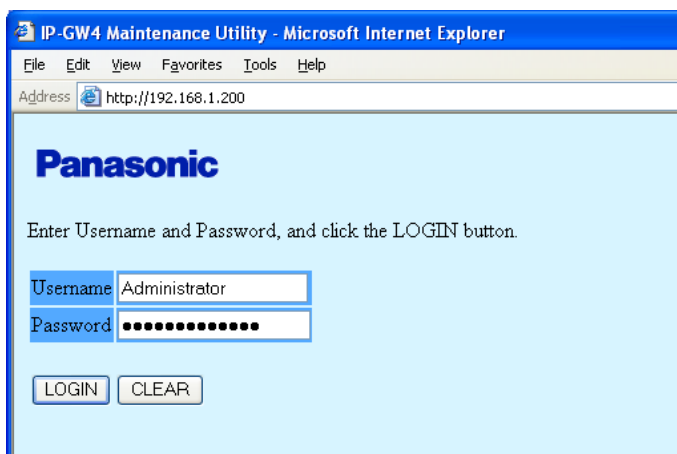

6. Click **LOGIN**.
To clear your entry, click **CLEAR**.

Notes

- If another user is already logged in, you will be rejected.
- For readability of the text on the screen, it is recommended that you adjust the text size of Internet Explorer to below medium.
- If you finish a programming session without logging out from the card (e.g., quitting Internet Explorer, or returning to the log-in screen with the "Back" button of Internet Explorer), you cannot log in again for the period of time specified by the parameter **Programming Auto Disconnect Time** (default: 10 min).
For the log-out procedure and **Programming Auto Disconnect Time** setting, refer to "2.5.2 Log Out"/"3.4.2 Log Out" and "2.3.2 Maintenance Settings", respectively.

Section 2

Administrator Functions

This section provides operating instructions for the IP-GW4 Maintenance Utility when logged in as the Administrator.

2.1 Main Menu for the Administrator

The IP-GW4 Maintenance Utility provides the following menu to a user logged in as the Administrator.



The screenshot shows a web browser window titled "IP-GW4 Maintenance Utility - Microsoft Internet Explorer". The address bar displays "http://192.168.1.200/ad_menu.html". The main content area has a light blue background and contains the following menu structure:

MENU

1. Programming
 - [1.1 Network Settings, General](#)
 - [1.2 H.323 Detailed Settings](#)
 - [1.3 Voice Communication Detailed Settings](#)
 - [1.4 VoIP Gateway/IP-PBX Interface Settings](#)
 - [1.5 Hunt Pattern \(for Incoming Calls\)](#)
 - [1.6 DN2IP \(Dialed Number to IP Address Translation\)](#)
 - [1.7 Initialization](#)
2. Maintenance
 - [2.1 Change RUN/STOP status](#)
 - [2.2 Maintenance Settings](#)
 - [2.3 Diagnosis](#)
 - [2.4 Log Information \(of interest to engineers only\)](#)
3. Data Management
 - [3.1 Upload of Configuration data \(PC -> VoIP Gateway\)](#)
 - [3.2 Download of Configuration data \(VoIP Gateway -> PC\)](#)
 - [3.3 Upload of DN2IP data \(PC -> VoIP Gateway\)](#)
 - [3.4 Download of DN2IP data \(VoIP Gateway -> PC\)](#)

[REBOOT](#)

[LOGOUT](#)

Programming

Menu	Section Reference
1.1 Network Settings, General	2.2.1 Network Parameters
1.2 H.323 Detailed Settings	2.2.2 H.323 Parameters
1.3 Voice Communication Detailed Settings	2.2.3 Voice Communication Parameters
1.4 VoIP Gateway/IP-PBX Interface Settings	2.2.4 VoIP Gateway/IP-PBX Interface Parameters
1.5 Hunt Pattern (for Incoming Calls)	2.2.5 Hunt Pattern Parameters
1.6 DN2IP (Dialed Number to IP Address Translation)	2.2.6 Address Translation Table—GW Entry 2.2.7 Address Translation Table—DN2IP Entry
1.7 Initialization	2.2.8 Initialization

Maintenance

Menu	Section Reference
2.1 Change RUN/STOP status	2.3.1 Status Control
2.2 Maintenance Settings	2.3.2 Maintenance Settings
2.3 Diagnosis	2.3.3 Diagnosis
2.4 Log Information	2.3.4 Log Information

Data Management

Menu	Section Reference
3.1 Upload of Configuration data (PC → VoIP Gateway)	2.4.1 Upload of Configuration Data
3.2 Download of Configuration data (VoIP Gateway → PC)	2.4.2 Download of Configuration Data
3.3 Upload of DN2IP data (PC → VoIP Gateway)	2.4.3 Upload of Address Translation Table
3.4 Download of DN2IP data (VoIP Gateway → PC)	2.4.4 Download of Address Translation Table

Others

Menu	Section Reference
REBOOT	2.5.1 Reboot
LOGOUT	2.5.2 Log Out

2.2 Programming

2.2.1 Network Parameters

1. Click **1.1 Network Settings, General** in the main menu.

The screenshot shows the IP-GW4 Maintenance Utility web interface in Microsoft Internet Explorer. The address bar shows the URL: http://192.168.1.200/ad_network.html. The interface includes buttons for OK, ALL CLEAR, MENU, and LOGOUT. The main content area is titled "1. Programming" and "1.1 Network Settings, General". It displays several configuration sections:

Current IP Address	192.168.1.200
Current Subnet Mask	255.255.0.0
Current Default Gateway	0.0.0.0

1.1.1 IP Address Settings

# IP Address	192.168.1.200
# Subnet Mask	255.255.0.0
# Default Gateway	0.0.0.0

1.1.2 DHCP Settings

# DHCP Server	<input type="radio"/> Use <input checked="" type="radio"/> Don't use
# DHCP Server Port No.	67
# DHCP Client Port No.	68
# DHCP Lease Time (min) 0-1440min (of interest to engineers only)	1440

1.1.3 HTTP Settings

# HTTP Port No.	80
-----------------	----

1.1.4 QSIG Connectionless Tunneling Settings

# QSIG Connectionless Tunneling Port No.	1718
--	------

1.1.5 Others

Host Name (of interest to engineers only)	VoIP313845
# LAN Disconnect Threshold Time (s)	5

indicates setting must be done in the STOP status, and must be followed by a REBOOT.

Current IP Address, Current Subnet Mask, and Current Default Gateway show the current IP address settings of the VoIP Gateway Card.

2. Assign each parameter referring to the descriptions below.

At any time during the session, you can:

- Click **ALL CLEAR** to return all parameters to their previous values.
- Click **MENU** to return to the main menu (see "2.1 Main Menu for the Administrator").
- Click **LOGOUT** to log out from the IP-GW4 Maintenance Utility (see "2.5.2 Log Out").

3. Click **OK**.

You will see a confirmation screen.

Note

If your entry contains an invalid value, you will be prompted to correct your input. Enter correct values for the parameters shown in red and try again.

4. Confirm your entry and click **OK**.

To return to the previous screen, click **CANCEL**.

Parameter Descriptions

The parameters indicated with "#" must be changed while the card is in the "STOP" status (see "2.3.1 Status Control"). The changes must be followed by a reboot to become effective (see "2.5.1 Reboot").

IP Address Settings

Parameter & Description	Default	Value Range
# IP Address Specifies the IP address of the card. For more information, consult your network administrator.	192.168.1.200	The following addresses are invalid: <ul style="list-style-type: none"> • Class D addresses • Class E addresses • Loopback addresses • Addresses with host number all 0s or 1s
# Subnet Mask Specifies the subnet mask address of the card. For more information, consult your network administrator.	255.255.255.0	Any address is valid.
# Default Gateway Specifies the default gateway IP address of the card. For more information, consult your network administrator.	0.0.0.0	Same as the parameter IP Address , except that the address 0.0.0.0. is allowed.

DHCP Settings

Parameter & Description	Default	Value Range
# DHCP Server Specifies the use of a DHCP server. For details, refer to "Detailed Explanations".	Don't use	Use, Don't use
# DHCP Server Port No. Specifies the port number for DHCP communications by the DHCP server. Generally, there is no need to change the default value.	67	1 to 65535
# DHCP Client Port No. Specifies the port number for DHCP communications by the card (the DHCP client). Generally, there is no need to change the default value.	68	1 to 65535
# DHCP Lease Time (min) 1-1440min This parameter is provided for engineer use only.	1440	0 (disable), 1 to 1440

HTTP Settings

Parameter & Description	Default	Value Range
<p># HTTP Port No.</p> <p>Specifies the port number for HTTP communications by the card.</p> <p>Generally, there is no need to change the default value.</p>	80	1 to 65535

QSIG Connectionless Tunneling Settings

Parameter & Description	Default	Value Range
<p># QSIG Connectionless Tunneling Port No.</p> <p>Specifies the port number for connectionless tunneling between cards at different locations in a QSIG network.</p> <p>Generally, there is no need to change the default value.</p> <p>Notes</p> <ul style="list-style-type: none"> • Connectionless tunneling enables the PBXs on a QSIG network to use enhanced networking features. (For more information about these features, refer to the relevant sections of the Hybrid IP-PBX documentation.) • If you are using a gatekeeper, and enhanced networking features of the PBX are being used, overall performance of the card may deteriorate when network traffic is heavy. • If you are using a gatekeeper, and "Routed" is specified for the parameter Call Signaling Model (see "2.2.2 H.323 Parameters"), connectionless tunneling is not possible. In this case, the PBX cannot use the enhanced networking features. 	1718	1 to 65535

Others

Parameter & Description	Default	Value Range
<p>Host Name</p> <p>This parameter is provided for engineer use only.</p>	VoIP + lower 3 bytes of the MAC address	Max. 255 characters
<p># LAN Disconnect Threshold Time (s)</p> <p>Specifies the time (in seconds) until disconnection from the LAN is recognized.</p> <p>For example, even if a LAN cable is disconnected during a call, reconnecting the cable within this time period maintains the call.</p>	5	1 to 10

Detailed Explanations

DHCP Server

When using the DHCP feature, the IP address settings of the card (IP address, subnet mask, and default gateway) will be assigned by a DHCP server.

However, keep in mind that the maintenance of the card is performed through a web browser from a PC; hence you must know the IP address of the card. Therefore, it is necessary to set up the DHCP server to assign a static IP address to the card from a pool of IP addresses that is defined in advance. For more information about DHCP server settings, consult your network administrator.

In addition, it is also necessary to specify the values for the parameters under **IP Address Settings** as they will be assigned by the DHCP server.

2.2.2 H.323 Parameters

1. Click **1.2 H.323 Detailed Settings** in the main menu.

IP-GW4 Maintenance Utility - Microsoft Internet Explorer
 File Edit View Favorites Tools Help
 Address http://192.168.1.200/ad_h323.html

OK ALL CLEAR MENU LOGOUT

1. Programming
 1.2 H.323 Detailed Settings

1.2.1 Port No. Settings

# H.225 Port No.	1720
# H.245 Port No.	1721
# RAS Port No.	1719
# RTP/RTCP Port No.	5004

1.2.2 Voice CODEC Settings

* Voice CODEC Priority	1st G.729A
	2nd None
	3rd None
	4th None

1.2.3 Gatekeeper Settings

# Gatekeeper	<input type="radio"/> Use <input checked="" type="radio"/> Don't use
* Primary Gatekeeper IP Address	192.168.1.3
* Primary Gatekeeper Port No.	1719
* Secondary Gatekeeper IP Address	192.168.1.4
* Secondary Gatekeeper Port No.	1719
* Gatekeeper Connection Checking Interval (min) 0-1440min	0
* Call Signaling Model	<input checked="" type="radio"/> Direct <input type="radio"/> Routed (via Gatekeeper)

1.2.4 Others

# Fast Connect	<input checked="" type="radio"/> Use <input type="radio"/> Don't use
----------------	--

indicates setting must be done in the STOP status, and must be followed by a REBOOT.
 * indicates setting must be done in the STOP status, and is not followed by a REBOOT.

2. Assign each parameter referring to the descriptions below.
 At any time during the session, you can:
 - Click **ALL CLEAR** to return all parameters to their previous values.
 - Click **MENU** to return to the main menu (see "2.1 Main Menu for the Administrator").
 - Click **LOGOUT** to log out from the IP-GW4 Maintenance Utility (see "2.5.2 Log Out").
3. Click **OK**.
 You will see a confirmation screen.

Note

If your entry contains an invalid value, you will be prompted to correct your input. Enter correct values for the parameters shown in red and try again.

4. Confirm your entry and click **OK**.
 To return to the previous screen, click **CANCEL**.

Parameter Descriptions

The parameters indicated with "#" must be changed while the VoIP Gateway Card is in the "STOP" status (see "2.3.1 Status Control"). The changes must be followed by a reboot to become effective (see "2.5.1 Reboot").

The parameters indicated with "*" must be changed while the card is in the "STOP" status (see "2.3.1 Status Control"). The changes do not have to be followed by a reboot to become effective.

Port Number Settings

Parameter & Description	Default	Value Range
# H.225 Port No. Specifies the port number for the H.225 protocol (call control) in an H.323 protocol suite. Generally, there is no need to change the default value.	1720	1 to 65535
# H.245 Port No. Specifies the port number for the H.245 protocol (negotiation of channel usage and capabilities) in an H.323 protocol suite. 4 consecutive ports, starting with the specified port, will be used (by default, 1721 to 1724). Generally, there is no need to change the default value.	1721	1 to 65532
# RAS Port No. Specifies the port number for the H.225 protocol (RAS) in an H.323 protocol suite. Generally, there is no need to change the default value.	1719	1 to 65535
# RTP/RTCP Port No. Specifies the port number for RTP/RTCP. 8 consecutive ports, starting with the specified port, will be used (by default, 5004 to 5011). Generally, there is no need to change the default value.	5004	1 to 65528

Voice CODEC Settings

Parameter & Description	Default	Value Range
* Voice CODEC Priority 1st–4th Specifies the type of CODEC for voice communications. Choose the appropriate CODEC for the network environment (e.g., bandwidth, CODEC conditions of the remote terminal). When using multiple CODECs, set them in an appropriate priority order. Prior to establishing a call, a negotiation takes place over the network and the CODEC to be used will be decided depending on the setting of this parameter. For details about relations between bandwidth and CODEC, refer to "Detailed Explanations" in "2.2.3 Voice Communication Parameters".	1st: G.729A 2nd: No default 3rd: No default 4th: No default	G.723.1, G.729A, G.711Mu, G.711A

Gatekeeper Settings

Parameter & Description	Default	Value Range
# Gatekeeper Specifies the use of a gatekeeper. For details, refer to "Detailed Explanations".	Don't use	Use, Don't use
* Primary Gatekeeper IP Address Specifies the IP address of the primary gatekeeper.	192.168.1.3	The following addresses are invalid: <ul style="list-style-type: none"> • Class D addresses • Class E addresses • Loopback addresses
* Primary Gatekeeper Port No. Specifies the port number of the primary gatekeeper.	1719	1 to 65535
* Secondary Gatekeeper IP Address Specifies the IP address of the secondary gatekeeper. Set this parameter when setting up a secondary gatekeeper as a redundant backup system.	192.168.1.4	The following addresses are invalid: <ul style="list-style-type: none"> • Class D addresses • Class E addresses • Loopback addresses
* Secondary Gatekeeper Port No. Specifies the port number of the secondary gatekeeper. Set this parameter when setting up a secondary gatekeeper as a redundant backup system.	1719	1 to 65535
* Gatekeeper Connection Checking Interval (min) 0-1440min Specifies the time (in minutes) between periodic checks of connection to the gatekeeper. When the primary gatekeeper fails, these checks can detect the failure. In this case, the connection automatically switches to the secondary gatekeeper if it is available, so that the network remains functional.	0	0 (disable), 1 to 1440
* Call Signaling Model Specifies whether to carry out a call control (H.225) process directly between the cards or through a gatekeeper. Direct call control is typically preferred because it involves less network load.	Direct	Direct, Routed (via Gatekeeper)

Others

Parameter & Description	Default	Value Range
# Fast Connect Specifies the use of the Fast Connect feature. Using Fast Connect simplifies the communication process so that calls can be established quickly. Generally, there is no need to change the default value.	Use	Use, Don't use

Detailed Explanations

Gatekeeper

The following are the general functions of a gatekeeper:

- Dialed number-to-IP address translation
- Authentication
- Bandwidth control

It is possible to employ a VoIP network without the use of a gatekeeper, because the card is equipped with internal address translation capabilities. However, should the network contain dozens of cards, maintenance of address translation tables in individual cards can become a strain.

A gatekeeper is useful in this case, because with the gatekeeper it is possible to consolidate the maintenance. (However, you still need to program each card on the network with its own address translation information. For details, refer to "2.2.6 Address Translation Table—GW Entry" and "2.2.7 Address Translation Table—DN2IP Entry".) For more information about gatekeeper functions, consult the documentation of the gatekeeper.

When using a gatekeeper, make sure to choose a compatible model. For more information about gatekeeper compatibility with the card, consult a certified dealer.

2.2.3 Voice Communication Parameters

1. Click **1.3 Voice Communication Detailed Settings** in the main menu.

IP-GW4 Maintenance Utility - Microsoft Internet Explorer

File Edit View Favorites Tools Help

Address http://192.168.1.200/ad_sound.html

OK ALL CLEAR MENU LOGOUT

1. Programming
1.3 Voice Communication Detailed Settings

1.3.1 QoS Field Settings

<input checked="" type="radio"/> ToS	Priority 0
<input type="radio"/> DSCP	<input type="text"/>
<input type="radio"/> HEX	<input type="text"/>
<input checked="" type="radio"/> Normal <input type="radio"/> Monetary Cost <input type="radio"/> Reliability <input type="radio"/> Throughput <input type="radio"/> Delay	

1.3.2 Jitter buffer Settings

G.711/G.729A Jitter Buffer Minimum (ms)	10
G.711/G.729A Jitter Buffer Maximum (ms)	400
G.711/G.729A Jitter Buffer Default Value (ms)	10
G.711/G.729A Jitter Buffer Adjustment Interval (s) 1-5s	1
G.723.1 Jitter Buffer Minimum (ms)	30
G.723.1 Jitter Buffer Maximum (ms)	1200
G.723.1 Jitter Buffer Default value (ms)	30
G.723.1 Jitter Buffer Adjustment Interval (s) 1-5s	1

1.3.3 CODEC Frame Settings

G.723.1 Packet Sending Interval (ms)	30
G.729A Packet Sending Interval (ms)	20
G.711 Packet Sending Interval (ms)	20

1.3.4 Others

Echo Canceller	<input checked="" type="radio"/> Use <input type="radio"/> Don't use
G.723.1 VAD (Voice Activity Detection)	<input checked="" type="radio"/> Use <input type="radio"/> Don't use
G.723.1 Rate	<input checked="" type="radio"/> 5.3Kbps <input type="radio"/> 6.3Kbps
DTMF Detection	<input checked="" type="radio"/> Use <input type="radio"/> Don't use
FAX Signal Detection	<input type="radio"/> Use <input checked="" type="radio"/> Don't use
FAX High Reliable Method (Original)	<input type="radio"/> Use <input checked="" type="radio"/> Don't use
DTMF Detection Level (dB) -20-0dB	-20

2. Assign each parameter referring to the descriptions below.
At any time during the session, you can:
 - Click **ALL CLEAR** to return all parameters to their previous values.
 - Click **MENU** to return to the main menu (see "2.1 Main Menu for the Administrator").
 - Click **LOGOUT** to log out from the IP-GW4 Maintenance Utility (see "2.5.2 Log Out").
3. Click **OK**.
You will see a confirmation screen.

Note

If your entry contains an invalid value, you will be prompted to correct your input. Enter correct values for the parameters shown in red and try again.

4. Confirm your entry and click **OK**.
To return to the previous screen, click **CANCEL**.

Parameter Descriptions

QoS Field Settings

The parameters below are used to set the ToS (Type of Service) field in the header of IP packets to control QoS of VoIP communications.

For more information about QoS, refer to "A1.4 QoS (Quality of Service)" of the VoIP Gateway Card Getting Started. For the actual setting values, consult your network administrator.

Parameter & Description	Default	Value Range
ToS Specifies the value in the ToS field by a generic term. For details, refer to "Detailed Explanations".	Priority: 0	0 to 7
	Normal	Normal, Monetary Cost, Reliability, Throughput, Delay
DSCP Specifies the value in the ToS field by a DSCP for DiffServ.	No default	0 to 63
HEX Specifies the value in the ToS field by a hexadecimal number.	No default	00 to FF

Jitter buffer Settings

When voice signals are packetized and transmitted, individual packets can take different paths through the network and arrive at the destination at varied timings. This is referred to as "jitter", and it can cause degradation in speech quality. To compensate for jitter problems, the "jitter buffer" accumulates the packets temporarily for processing.

The parameters below are used to adjust the size of the jitter buffer. However, in general, there is no need to change the default values.

Parameter	Default	Value Range
G.711/G.729A Jitter Buffer Minimum (ms)	10	$10 \times n$ ($n = 1-40$)
G.711/G.729A Jitter Buffer Maximum (ms)	400	$10 \times n$ ($n = 1-40$)
G.711/G.729A Jitter Buffer Default Value (ms)	10	$10 \times n$ ($n = 1-40$)
G.711/G.729A Jitter Buffer Adjustment Interval (s) 1-5s	5	1 to 5
G.723.1 Jitter Buffer Minimum (ms)	30	$30 \times n$ ($n = 1-40$)
G.723.1 Jitter Buffer Maximum (ms)	1200	$30 \times n$ ($n = 1-40$)
G.723.1 Jitter Buffer Default value (ms)	30	$30 \times n$ ($n = 1-40$)
G.723.1 Jitter Buffer Adjustment Interval (s) 1-5s	5	1 to 5

CODEC Frame Settings

The parameters below are used to set the interval between packet transmissions for each type of CODEC. It is recommended that all VoIP Gateway Cards in a VoIP network have the same settings for these parameters. For details, refer to "Detailed Explanations".

Parameter	Default	Value Range
G.723.1 Packet Sending Interval (ms)	30	30, 60, 90
G.729A Packet Sending Interval (ms)	20	20, 30, 40
G.711 Packet Sending Interval (ms)	20	20, 30, 40

Others

Parameter & Description	Default	Value Range
<p>Echo Canceller Specifies the use of the echo cancellation feature (G.168). Echo is the audible duplication of a caller's voice on the return path; when echo exists, the caller hears his or her own voice after some delay. The echo canceller eliminates this echo.</p> <p>Note There are various factors that may cause an echo. In some cases, this feature does not eliminate the echo entirely.</p>	Use	Use, Don't use
<p>G.723.1 VAD (Voice Activity Detection) Specifies the use of the VAD feature (G.723.1). The VAD conserves bandwidth by detecting silent periods during a call and suppressing the packets of silence from being sent to the network.</p> <p>Note To use this feature, both the local and remote cards must have this parameter set to "Use".</p>	Use	Use, Don't use
<p>G.723.1 Rate Specifies the rate of the G.723.1 CODEC.</p>	6.3Kbps	5.3Kbps, 6.3Kbps
<p>DTMF Detection Specifies the use of the DTMF detection feature. DTMF detection enables end-to-end DTMF relay over the network. For details, refer to "Detailed Explanations".</p>	Use	Use, Don't use
<p>FAX Signal Detection Specifies the use of the fax signal detection feature. Fax signal detection enables end-to-end fax signal relay over the network. For details, refer to "Detailed Explanations".</p>	Don't use	Use, Don't use

Parameter & Description	Default	Value Range
FAX High Reliable Method (Original) Specifies the use of the packet multiplexing feature during fax communications. For details, refer to "Detailed Explanations".	Don't use	Use, Don't use
DTMF Detection Level (dB) -20-0dB Specifies the level (in decibels) of DTMF detection. Generally, there is no need to change the default value.	-20	-20 to 0

Detailed Explanations

QoS Field Settings

The following diagrams show the bit values of the ToS field in the IP header in relation to the setting values for the parameters under **QoS Field Settings**:

ToS

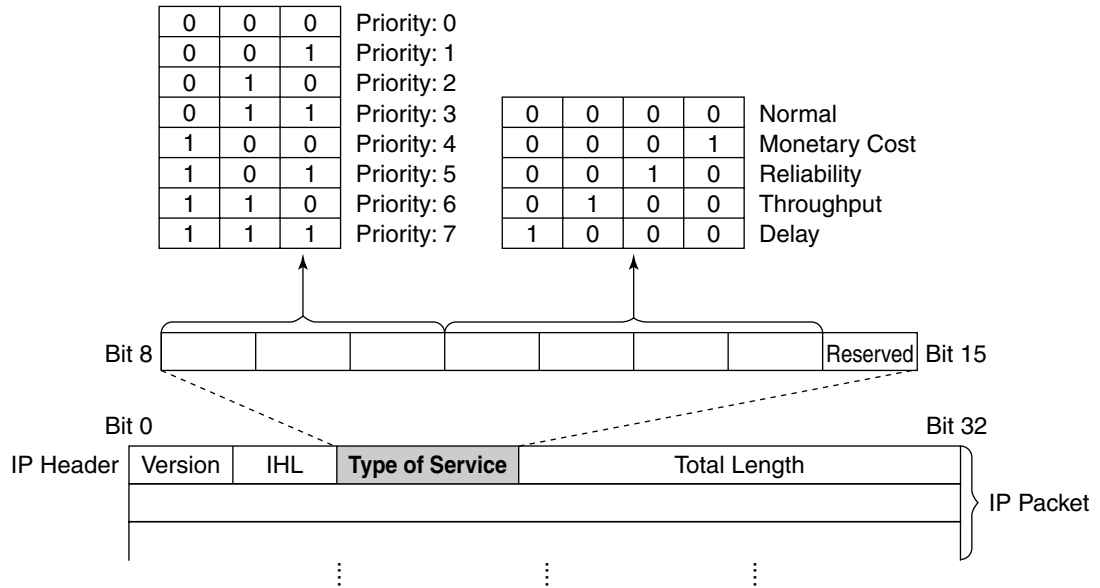

DSCP

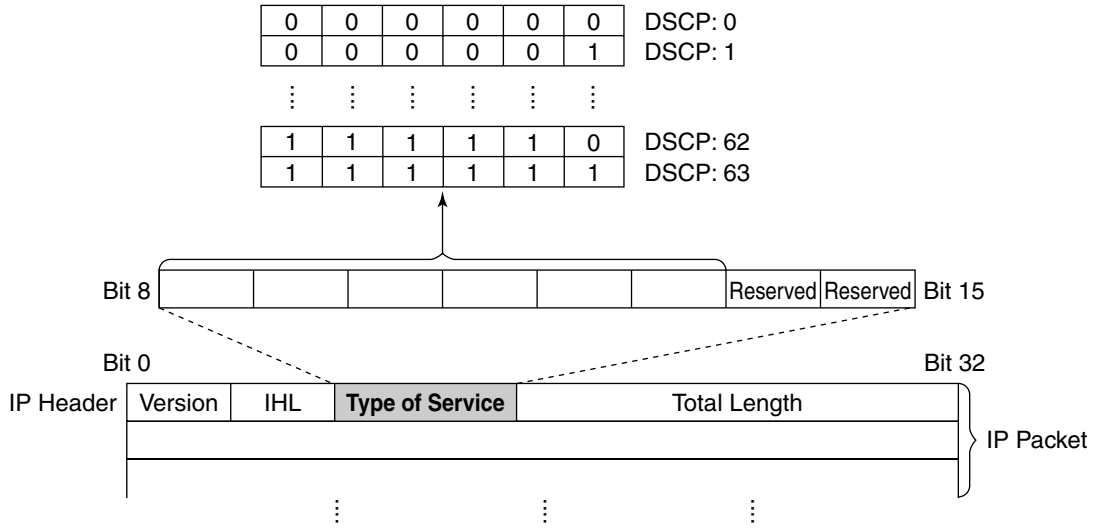

HEX

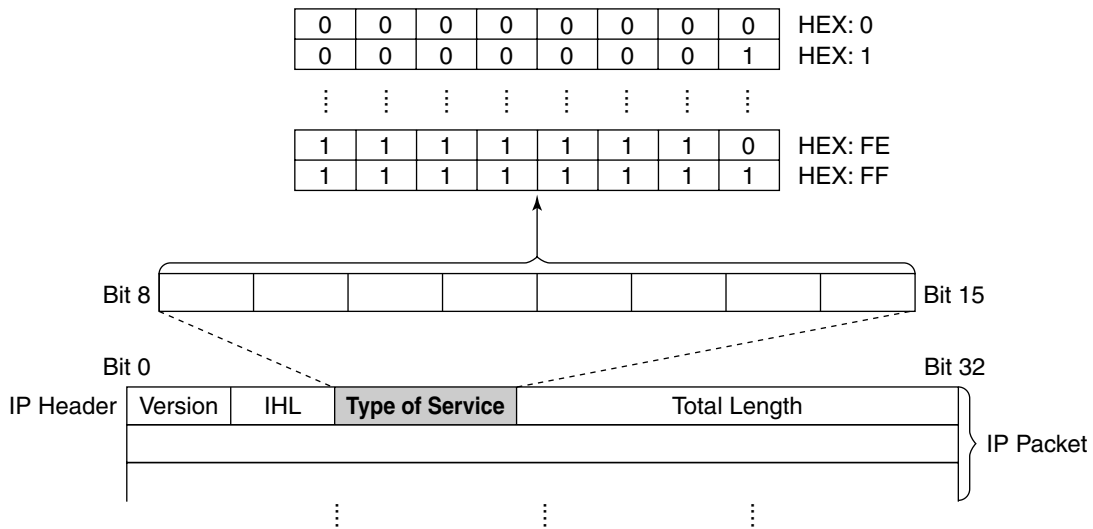

CODEC Frame Settings

The amount of required bandwidth depends on the type of CODEC and the selected packet sending interval. The tables below show the amount of bandwidth required for one VoIP channel in each case:

Required Bandwidth for Voice Communication via LAN

CODEC	Packet Sending Interval				
	20 ms	30 ms	40 ms	60 ms	90 ms
G.711	87.2 kbps	79.5 kbps	75.6 kbps	—	—
G.729A	31.2 kbps	23.5 kbps	19.6 kbps	—	—
G.723.1 5.3 kbps	—	20.8 kbps	—	13.1 kbps	10.5 kbps
G.723.1 6.3 kbps	—	21.9 kbps	—	14.1 kbps	11.6 kbps

Required Bandwidth for Voice Communication via WAN (PPP: Point-to-Point Protocol)

CODEC	Packet Sending Interval				
	20 ms	30 ms	40 ms	60 ms	90 ms
G.711	84 kbps	77.3 kbps	74 kbps	—	—
G.729A	28 kbps	21 kbps	18 kbps	—	—
G.723.1 5.3 kbps	—	18.7 kbps	—	12 kbps	9.8 kbps
G.723.1 6.3 kbps	—	19.7 kbps	—	13.1 kbps	10.8 kbps

When assessing your bandwidth requirements, keep in mind that the longer the packet sending interval, the smaller the amount of required bandwidth, and vice versa.

However, also consider that the shorter the packet sending interval, the clearer the expected speech quality, because delays in packet transmissions will be small. When the packet sending interval is long, delays are more likely to occur, resulting in overall degradation in speech quality with more pauses and loss in voice communications.

Therefore, it is recommended that you select the shortest packet sending interval that network bandwidth can accommodate.

DTMF Detection

A VoIP network does not guarantee accurate end-to-end transmission of DTMF signals because the DTMF signals are coded/decoded during VoIP communications, in the same way as voice signals. In addition, packets can get lost during transmission.

To compensate for this problem, it is possible to enable DTMF detection for the VoIP Gateway Card to carry out accurate end-to-end DTMF relay over the network. Upon detecting DTMF signals from the PBX, the card encodes the signals and then sends them to the destination, instead of as voice signals. Then at the destination, the card regenerates the DTMF signals from the received encoded signals, and then sends them to the PBX.

Note that when this feature is enabled, the sending of packets is delayed by approximately 30 ms. Therefore, it is recommended that you disable this feature unless DTMF detection is necessary.

FAX Signal Detection

When sending fax signals using a CODEC other than G.711, the signals cannot be received accurately at the destination because they are coded/decoded over the VoIP network, in the same way as voice signals.

To compensate for this problem, it is possible to enable fax detection for the card. Upon detecting fax signals (CED tones) from the PBX, the card automatically switches the CODEC to G.711 to communicate with the card at the destination. With the G.711 CODEC, it is possible to assure error-free fax communications to a certain extent.

To further assure fax communications, it is strongly recommended that the communicating fax machines be equipped with the ECM (Error Correction Model) feature, an automatic error correction feature. When, for example, the receiving fax machine detects errors in transmission, it can have the sending fax machine resend the relevant data.

When using the fax detection feature, the communicating cards must share the same value (either "G.711Mu" or "G.711A") for the parameter **Voice CODEC Priority** (see "Voice CODEC Settings" in "2.2.2 H.323 Parameters").

FAX High Reliable Method

If ECM-capable fax machines are not available, it is necessary to use the **"FAX High Reliable Method"** (a proprietary feature of the card). This feature is used to multiplex the packets when sending them over the network for protection against packet loss. Hence it is possible to achieve reliable fax communications without using ECM-capable fax machines.

However, keep in mind that this feature does not entirely guarantee error-free fax communications. Also, more bandwidth is required for one VoIP channel when using this feature. The tables below show the amount of bandwidth required for one VoIP channel when this feature is in use and not in use:

Required Bandwidth for Fax Communication via LAN

FAX High Reliable Method	G.711 Packet Sending Interval		
	20 ms	30 ms	40 ms
Don't Use	87.2 kbps	79.5 kbps	75.6 kbps
Use	224.8 kbps	213.9 kbps	208.4 kbps

Required Bandwidth for Fax Communication via WAN (PPP: Point-to-Point Protocol)

FAX High Reliable Method	G.711 Packet Sending Interval		
	20 ms	30 ms	40 ms
Don't Use	84 kbps	77.3 kbps	74 kbps
Use	221.6 kbps	211.7 kbps	206.8 kbps

Notes

- To carry out fax communications between the KX-TDA5480/KX-TDA0484 and KX-TDA0490 VoIP Gateway Cards, it is necessary to disable the **"FAX High Reliable Method"** for the KX-TDA5480/KX-TDA0484 card.
- Fax communications cannot take place between the KX-TDA5480/KX-TDA0484 and KX-TDA0480 VoIP Gateway Cards.
- Fax communications in the Super G3 mode are not guaranteed.

2.2.4 VoIP Gateway/IP-PBX Interface Parameters

1. Click **1.4 VoIP Gateway/IP-PBX Interface Settings** in the main menu.

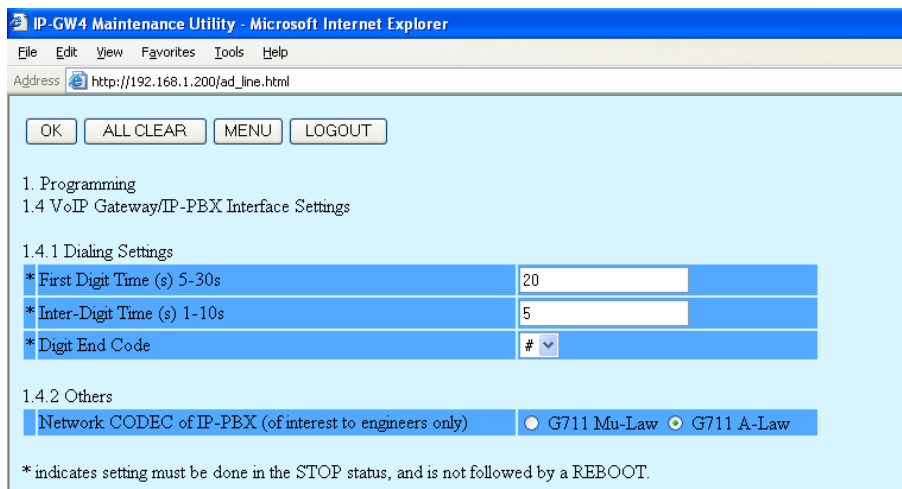

IP-GW4 Maintenance Utility - Microsoft Internet Explorer

File Edit View Favorites Tools Help

Address http://192.168.1.200/ad_line.html

OK ALL CLEAR MENU LOGOUT

1. Programming
1.4 VoIP Gateway/IP-PBX Interface Settings

1.4.1 Dialing Settings

*First Digit Time (s) 5-30s	20
*Inter-Digit Time (s) 1-10s	5
*Digit End Code	#

1.4.2 Others

Network CODEC of IP-PBX (of interest to engineers only) G711 Mu-Law G711 A-Law

* indicates setting must be done in the STOP status, and is not followed by a REBOOT.

2. Assign each parameter referring to the descriptions below.

At any time during the session, you can:

- Click **ALL CLEAR** to return all parameters to their previous values.
- Click **MENU** to return to the main menu (see "2.1 Main Menu for the Administrator").
- Click **LOGOUT** to log out from the IP-GW4 Maintenance Utility (see "2.5.2 Log Out").

3. Click **OK**.

You will see a confirmation screen.

Note

If your entry contains an invalid value, you will be prompted to correct your input. Enter correct values for the parameters shown in red and try again.

4. Confirm your entry and click **OK**.

To return to the previous screen, click **CANCEL**.

Parameter Descriptions

The parameters indicated with "*" must be changed while the VoIP Gateway Card is in the "STOP" status (see "2.3.1 Status Control"). The changes do not have to be followed by a reboot to become effective.

Dialing Settings

Parameter & Description	Default	Value Range
<p>* First Digit Time (s) 5-30s</p> <p>Specifies the length of time (in seconds) within which the first digit of a dial number must be dialed after seizing a VoIP gateway trunk (CO line).</p> <p>Generally, there is no need to change the default value.</p>	20	5 to 30

Parameter & Description	Default	Value Range
<p>* Inter-Digit Time (s) 1-10s</p> <p>Specifies the length of time (in seconds) within which subsequent digits of a dial number must be dialed. Generally, there is no need to change the default value.</p>	5	1 to 10
<p>* Digit End Code</p> <p>Specifies the delimiter code to be used to signal the end of a dial number. Generally, there is no need to change the default value.</p>	#	0 to 9, #, *

Others

Parameter & Description	Default	Value Range
<p>Network CODEC of IP-PBX</p> <p>The value of this parameter is set automatically as appropriate to the setting of the PBX. There is no need to change the value.</p>	Not applicable	G.711 Mu-Law, G.711 A-Law

2.2.5 Hunt Pattern Parameters

1. Click **1.5 Hunt Pattern (for Incoming Calls)** in the main menu.

IP-GW4 Maintenance Utility - Microsoft Internet Explorer

File Edit View Favorites Tools Help

Address http://192.168.1.200/ad_hunt_pattern.html

OK ALL CLEAR MENU LOGOUT

1. Programming
1.5 Hunt Pattern (for Incoming Calls)

1.5.1 Hunt Group

	Port1	Port2
* Hunt Group	Hunt group 1	Hunt group 1

1.5.2 Hunt Pattern Entry

Hunt Pattern No. (1-16)	
* Receive Leading Number	
Hunt Group (Priority1)	1
Hunt Group (Priority2)	-

* indicates setting must be done in the STOP status, and is not followed by a REBOOT.

ENTRY

Sort Option

Hunt Pattern No.	Ascending Order
------------------	-----------------

SORT

Hunt Pattern No.	Receive Leading Number	Hunt Group	DELETE
------------------	------------------------	------------	--------

2. Assign each parameter referring to the descriptions below.
At any time during the session, you can:
 - Click **ALL CLEAR** to return all parameters to their previous values.
 - Click **MENU** to return to the main menu (see "2.1 Main Menu for the Administrator").
 - Sort the hunt patterns in the table at the bottom of the screen:
 - a. Click the desired sort key and sort order from the **Sort Option** lists.
 - b. Click **SORT**.
 - Delete the desired hunt pattern from the table at the bottom of the screen:
 - a. Select the appropriate check box for the hunt pattern you want to delete.
 - b. Click **DELETE**.
 - Click **LOGOUT** to log out from the IP-GW4 Maintenance Utility (see "2.5.2 Log Out").
3. Click **ENTRY**.
A maximum of 16 hunt patterns can be created.
4. Click **OK**.
You will see a confirmation screen.

Note

If your entry contains an invalid value, you will be prompted to correct your input. Enter correct values for the parameters shown in red and try again.

5. Confirm your entry and click **OK**.
To return to the previous screen, click **CANCEL**.

Parameter Descriptions

The parameters indicated with "*" must be changed while the VoIP Gateway Card is in the "STOP" status (see "2.3.1 Status Control"). The changes do not have to be followed by a reboot to become effective.

Hunt Group

The parameters below are used to assign VoIP gateway ports 1 and 2 to the hunt groups.

For details, refer to "Detailed Explanations".

Parameter	Default	Value Range
* Port1	Hunt group 1	Hunt group 1, Hunt group 2
* Port2	Hunt group 1	Hunt group 1, Hunt group 2

Hunt Pattern Entry

The parameters below are used to create hunt patterns.

For details, refer to "Detailed Explanations".

Parameter & Description	Default	Value Range
* Hunt Pattern No. Specifies the number for the hunt pattern to be created. When changing the current settings of an existing hunt pattern, first delete the hunt pattern and then re-create with new values.	No default	1 to 16
* Receive Leading Number Specifies the leading digits in received numbers by which to determine the hunt group to direct incoming calls. For example, to direct incoming calls with numbers starting with "9", specify the number "9" in this parameter. Likewise, to direct incoming calls with numbers starting with "1", specify the number "1". However, if you want to direct incoming calls with numbers starting with "950" and "951" to separate hunt groups, it is necessary to make 2 hunt patterns with respective numbers, "950" and "951".	No default	Max. 30 digits
* Hunt Group (Priority1) Specifies the hunt group to which incoming calls are directed first.	1	1, 2
* Hunt Group (Priority2) Specifies the hunt group to which incoming calls are directed when the VoIP gateway port assigned to Hunt Group (Priority1) is busy.	-	1, 2, - (disable)

Detailed Explanations

The card and the PBX are connected with 2 VoIP gateway ports, each of which has 2 communication channels, in much the same way as an ISDN BRI port.

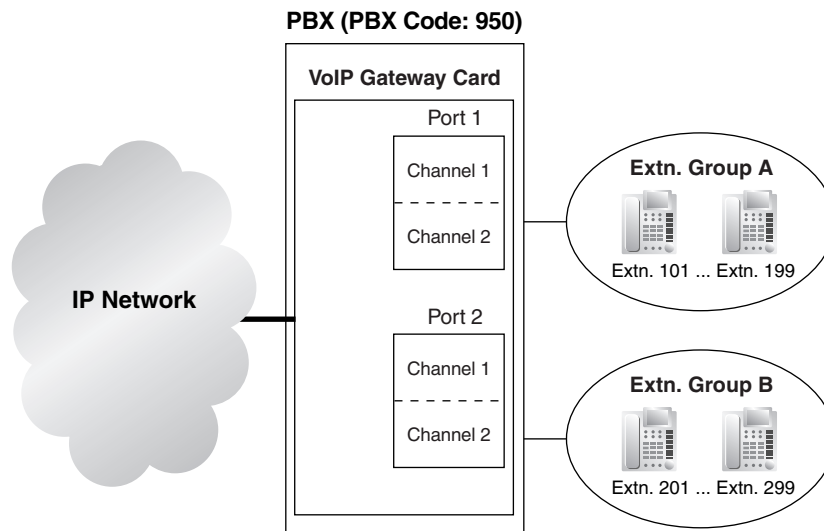

Hunt pattern programming determines the VoIP gateway ports through which to route incoming calls, depending on the received numbers. The following examples provide 2 different methods of hunt pattern programming.

Example 1

The following configuration is used to allocate 2 VoIP gateway ports (4 channels) to route incoming calls to both extension groups A and B.

When there are 4 incoming calls to extension group A in this configuration, no call can be routed to extension group B.

Hunt Group

	Port1	Port2
Hunt Group	Hunt group 1	Hunt group 1

Hunt Pattern Entry

Hunt Pattern No.	1
Receive Leading Number	9
Hunt Group (Priority1)	1
Hunt Group (Priority2)	-

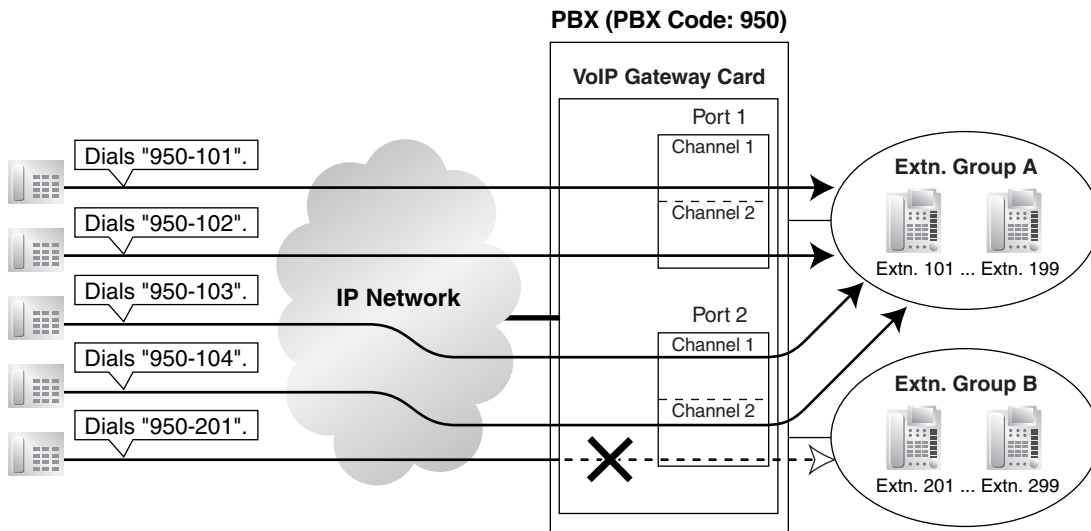

Example 2

The following configuration is used to allocate a single VoIP gateway port (2 channels) to individual extension groups. Specifically, with this configuration, calls to extension group A are routed through the port 1, and calls to extension group B are routed through the port 2.

This configuration rejects the third call to extension group A, while reserving the other port (the other 2 channels) through which to route calls to extension group B.

Hunt Group

	Port1	Port2
Hunt Group	Hunt group 1	Hunt group 2

Hunt Pattern Entry—1

Hunt Pattern No.	1
Receive Leading Number	9501
Hunt Group (Priority1)	1
Hunt Group (Priority2)	-

Hunt Pattern Entry—2

Hunt Pattern No.	2
Receive Leading Number	9502
Hunt Group (Priority1)	2
Hunt Group (Priority2)	-

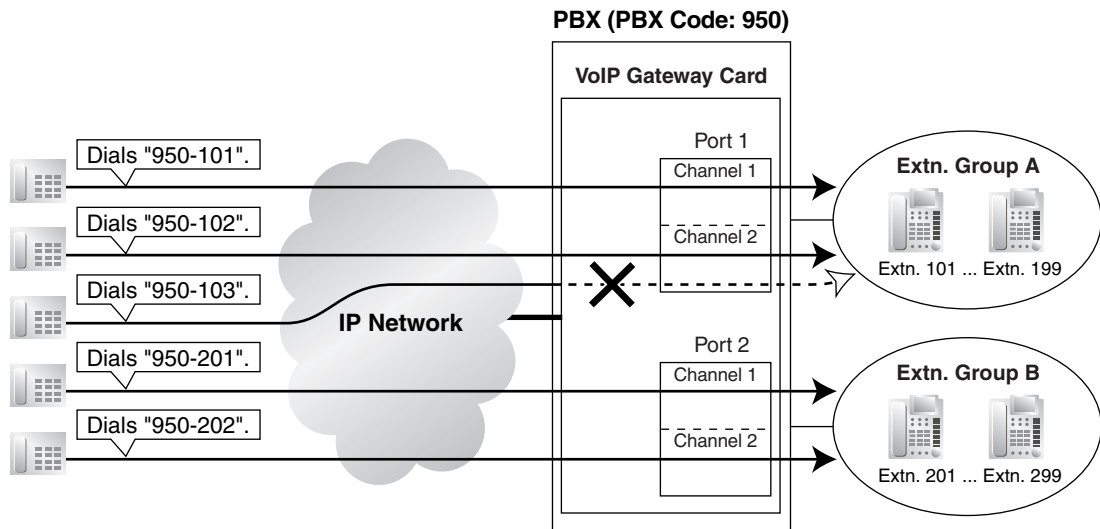

It is possible to program the PBX to allocate a single VoIP gateway port to individual extension groups A and B for making outgoing calls. With this programming, each extension group A and B can have a port for its exclusive use.

- The VoIP gateway port the extension group A uses to make outgoing calls: port 1
- The VoIP gateway port the extension group B uses to make outgoing calls: port 2

2.2.6 Address Translation Table—GW Entry

1. Click **1.6 DN2IP (Dialed Number to IP Address Translation)** in the main menu.

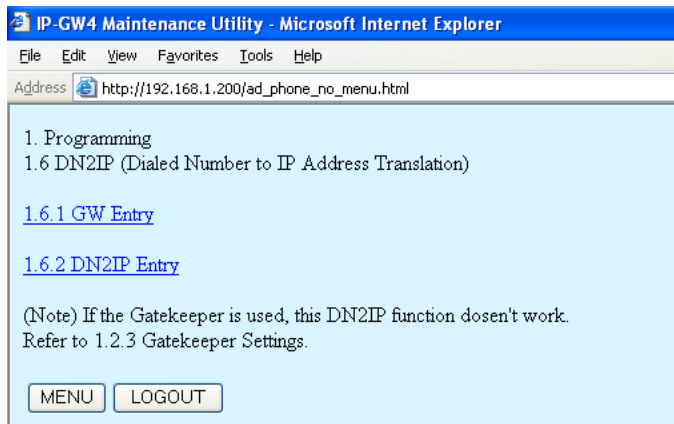

2. Click **1.6.1 GW Entry**.

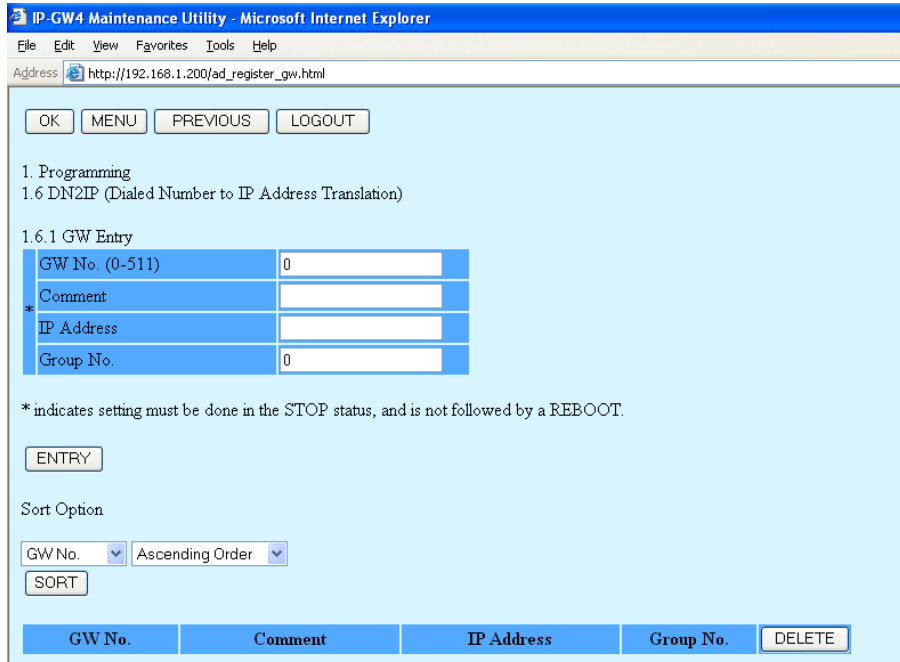

3. Assign each parameter referring to the descriptions below.

At any time during the session, you can:

- Click **MENU** to return to the main menu (see "2.1 Main Menu for the Administrator").
- Click **PREVIOUS** to return to the previous screen.
- Sort the gateway entries in the table at the bottom of the screen:
 - a. Click the desired sort key and sort order from the **Sort Option** lists.
 - b. Click **SORT**.

- Delete the desired gateway entry from the table at the bottom of the screen:
 - a. Select the appropriate check box for the gateway entry you want to delete.

Note

If the gateway entry is registered to a DN2IP entry (see "2.2.7 Address Translation Table—DN2IP Entry"), no check box will be shown for the gateway entry.

- b. Click **DELETE**.
- Click **LOGOUT** to log out from the IP-GW4 Maintenance Utility (see "2.5.2 Log Out").
4. Click **ENTRY**.
A maximum of 512 gateway entries can be created.
 5. Click **OK**.
You will see a confirmation screen.

Note

If your entry contains an invalid value, you will be prompted to correct your input. Enter correct values for the parameters shown in red and try again.

6. Confirm your entry and click **OK**.
To return to the previous screen, click **CANCEL**.

Parameter Descriptions

The parameters indicated with "*" must be changed while the VoIP Gateway Card is in the "STOP" status (see "2.3.1 Status Control"). The changes do not have to be followed by a reboot to become effective.

GW Entry

The parameters below are used to create gateway entries for both local and remote cards on the network, as a preliminary step to programming the address translation table (DN2IP).

For a programming example, refer to "4.2.5 Programming the Address Translation Table" of the VoIP Gateway Card Getting Started.

Note

If you are using a gatekeeper, create the gateway entry only for the local card.

Parameter & Description	Default	Value Range
<p>* GW No. Specifies the number for the gateway entry to be created. When changing the current settings of an existing gateway entry, first delete the gateway entry and then re-create with new values.</p>	0	0 to 511
<p>* Comment Specifies the comment for the gateway entry.</p>	No default	Max. 16 characters
<p>* IP Address Specifies the IP address of the card.</p>	No default	<p>The following addresses are invalid:</p> <ul style="list-style-type: none"> • Class D addresses • Class E addresses • Loopback addresses

Parameter & Description	Default	Value Range
<p>* Group No.</p> <p>Specifies the number of the gateway group to which the gateway entry belongs.</p> <p>Grouping is useful when there is more than one card installed in a PBX, because it allows you to use the automatic route redirection feature. For details, refer to "Detailed Explanations" in the next section, "2.2.7 Address Translation Table—DN2IP Entry".</p>	0	0 (belong to no group), 1 to 256

2.2.7 Address Translation Table—DN2IP Entry

1. Click **1.6 DN2IP (Dialed Number to IP Address Translation)** in the main menu.

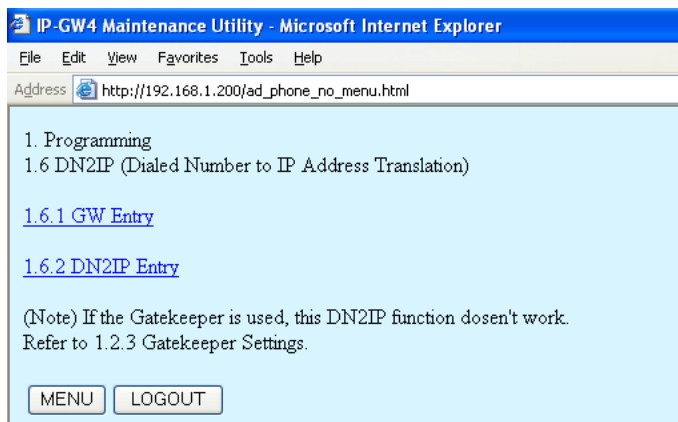

2. Click **1.6.2 DN2IP Entry**.

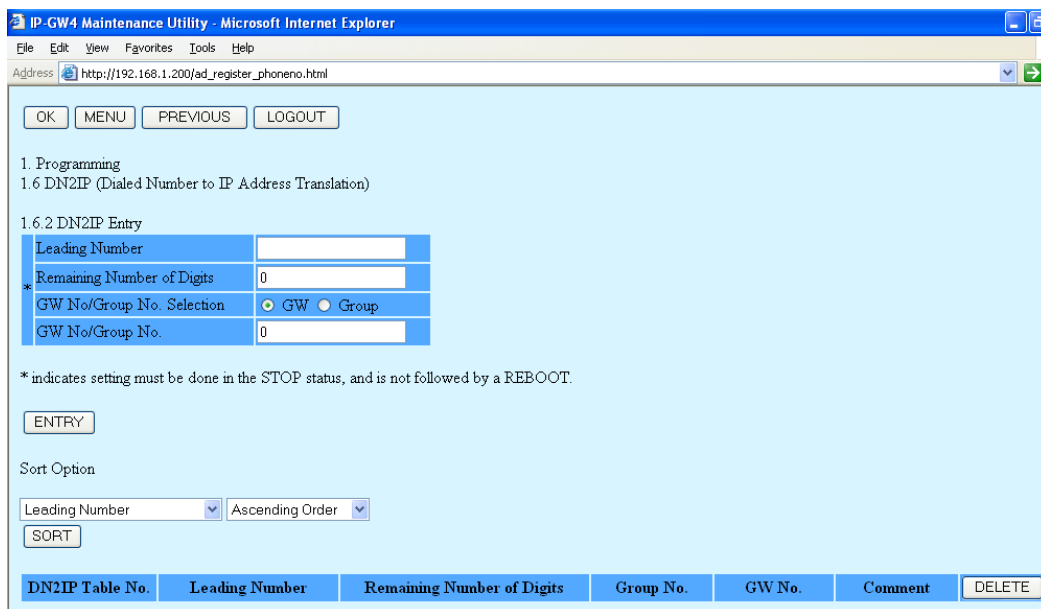

3. Assign each parameter referring to the descriptions below.
At any time during the session, you can:
 - Click **MENU** to return to the main menu (see "2.1 Main Menu for the Administrator").
 - Click **PREVIOUS** to return to the previous screen.
 - Sort the DN2IP entries in the table at the bottom of the screen:
 - a. Click the desired sort key and sort order from the **Sort Option** lists.
 - b. Click **SORT**.
 - Delete the desired DN2IP entry from the table at the bottom of the screen:
 - a. Select the appropriate check box for the DN2IP entry you want to delete.
 - b. Click **DELETE**.
 - Click **LOGOUT** to log out from the IP-GW4 Maintenance Utility (see "2.5.2 Log Out").
4. Click **ENTRY**.
A maximum of 512 DN2IP entries can be created.

- Click **OK**.
You will see a confirmation screen.

Note

If your entry contains an invalid value, you will be prompted to correct your input. Enter correct values for the parameters shown in red and try again.

- Confirm your entry and click **OK**.
To return to the previous screen, click **CANCEL**.

Parameter Descriptions

The parameters indicated with "*" must be changed while the VoIP Gateway Card is in the "STOP" status (see "2.3.1 Status Control"). The changes do not have to be followed by a reboot to become effective.

DN2IP Entry

The parameters below are used to create DN2IP entries based on the gateway entries created previously (see "2.2.6 Address Translation Table—GW Entry"). The DN2IP entries associate dialed numbers and IP address of the destination; therefore, a caller can reach the destination by dialing the number without knowing the destination IP address.

For a programming example, refer to "4.2.5 Programming the Address Translation Table" of the VoIP Gateway Card Getting Started.

Note

If you are using a gatekeeper, create the DN2IP entries only for the local card. In this case, you can create up to 4 DN2IP entries per card.
Note that if you are not using a gatekeeper, there is no maximum number of DN2IP entries.

Parameter & Description	Default	Value Range
<p>* Leading Number Specifies the leading digits in dialed numbers by which to associate calls with the appropriate destination. For example, to associate calls with dialed numbers "950-xxxx" and "951-xxxx" with separate destinations, it is necessary to make 2 DN2IP entries with respective numbers, "950" and "951".</p>	No default	Max. 30 digits
<p>* Remaining Number of Digits Specifies the number of digits to be dialed following the leading number to access the destination. For example, if the dialed numbers are either "950-xxxx" or "951-xxxx" and the numbers "950" and "951" are specified for the parameter Leading Number respectively, specify the number "4" in this parameter.</p>	0	0 to 29
<p>* GW No/Group No. Selection Specifies the type of destination when making calls: a gateway or a gateway group.</p>	GW	GW, Group
<p>* GW No/Group No. Specifies the number of the destination gateway or gateway group.</p>	GW No: 0, Group No.: 1	GW No: 0 to 511, Group No.: 1 to 256

Detailed Explanations

Automatic Route Redirection

When more than one card is installed in a PBX, you can assign them to a single gateway group. Grouping allows you to logically combine the channels of multiple cards in a PBX (there are 4 channels per card). This aids the effective use of channels in a PBX.

The following diagram and tables provide an example of this configuration.

Example of Configuration

In the diagram below, there are 2 cards (cards B and C) installed in PBX 2.

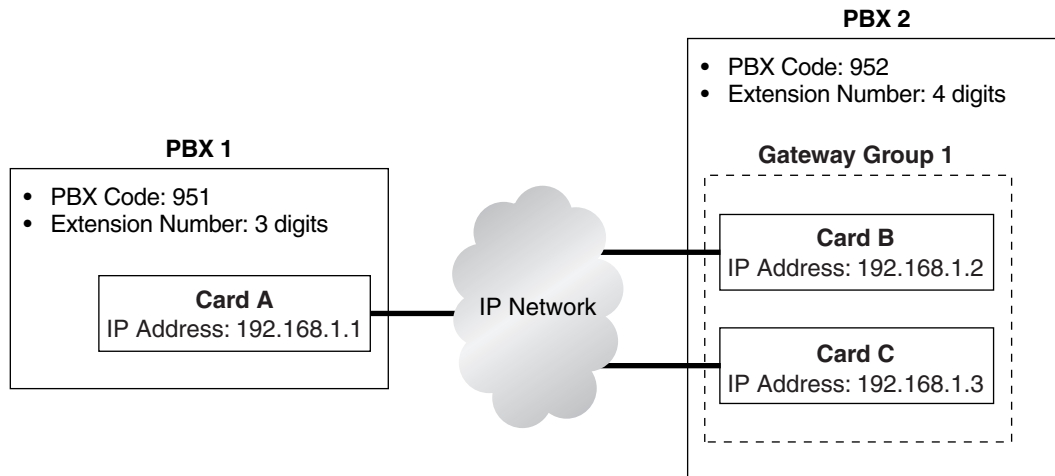

Example of Gateway Entry Programming

Through gateway entry programming, cards B and C are grouped into a single gateway group.

Parameter	Card A	Card B	Card C
GW No	0	1	2
Comment	IP-GW Card A	IP-GW Card B	IP-GW Card C
IP Address	192.168.1.1	192.168.1.2	192.168.1.3
Group No.	0	1	1

Example of DN2IP Entry Programming

When DN2IP entries are programmed as in the table below, calls through card A arrive at gateway group 1, which includes cards B and C.

Parameter	To Card A	To Gateway Group 1 (Cards B and C)
Leading Number	951	952
Remaining Number of Digits	3	4
GW No/Group No. Selection	GW	Group
GW No/Group No.	0	1

2.2 Programming

The automatic route redirection feature activates in this configuration. If a call is made through card A to gateway group 1 when all 4 channels of card B are busy, card A automatically redirects the call to card C.

This is possible because by grouping, PBX 1 sees PBX 2 as having a combined set of 8 channels, not 2 separate sets of 4 channels.

Note

The automatic route redirection feature cannot be used in a network where a gatekeeper is used. For details about gatekeeper settings, refer to "Gatekeeper Settings" in "2.2.2 H.323 Parameters".

2.2.8 Initialization

1. Click **1.7 Initialization** in the main menu.

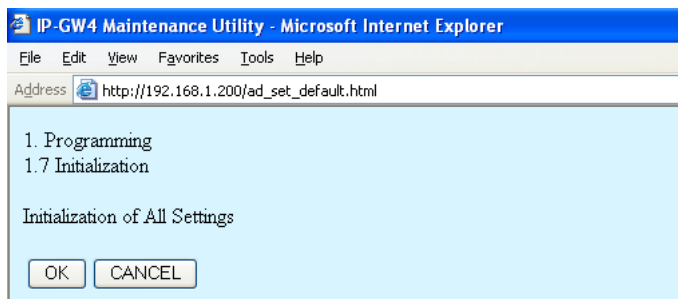

2. Click **OK** to initialize all parameters to the default values.

To abort initialization, click **CANCEL**. You will be taken back to the main menu (see "2.1 Main Menu for the Administrator").

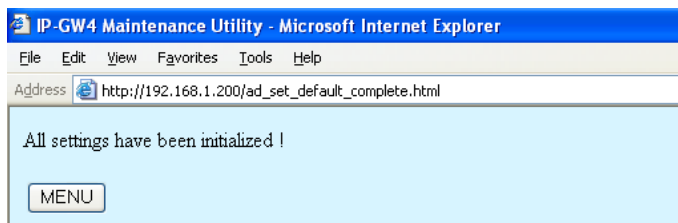

Initialization has to be followed by a reboot to make the default values effective for the parameters indicated with "#" (e.g., IP address of the VoIP Gateway Card). If not followed by a reboot, the current setting values will remain effective instead.

3. Click **MENU** to return to the main menu (see "2.1 Main Menu for the Administrator").
4. Refer to "2.5.1 Reboot" and finish the reboot.

Note

If you have forgotten the IP address or log-in password of the VoIP Gateway Card, follow the procedure detailed in "C1 Initializing the VoIP Gateway Card" of the VoIP Gateway Card Getting Started to return all settings to the factory default.

2.3 Maintenance

2.3.1 Status Control

1. Click **2.1 Change RUN/STOP status** in the main menu.

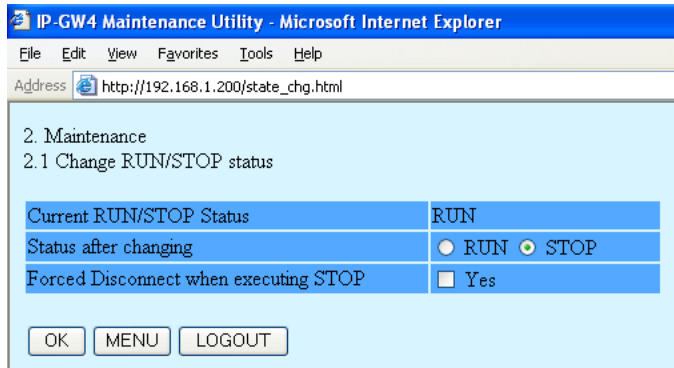

Current RUN/STOP Status shows the current status of the VoIP Gateway Card.

2. Click **RUN** or **STOP** for **Status after changing**.

If you want to forcibly change the status from "RUN" to "STOP" while there are ongoing calls, click the **Yes** check box for **Forced Disconnect when executing STOP**. This will allow you to place the card in the "STOP" status even when there are ongoing calls.

At any time during the session, you can:

- Click **MENU** to return to the main menu (see "2.1 Main Menu for the Administrator").
- Click **LOGOUT** to log out from the IP-GW4 Maintenance Utility (see "2.5.2 Log Out").

3. Click **OK**.

You will see a confirmation screen.

4. Click **OK**.

You will see a result screen.

Note

If the operation is not successful, you will see an error screen. Click **OK** to return to the previous screen, and then try again.

5. Click **OK**.

You will be taken back to the **Change RUN/STOP status** screen.

2.3.2 Maintenance Settings

1. Click **2.2 Maintenance Settings** in the main menu.

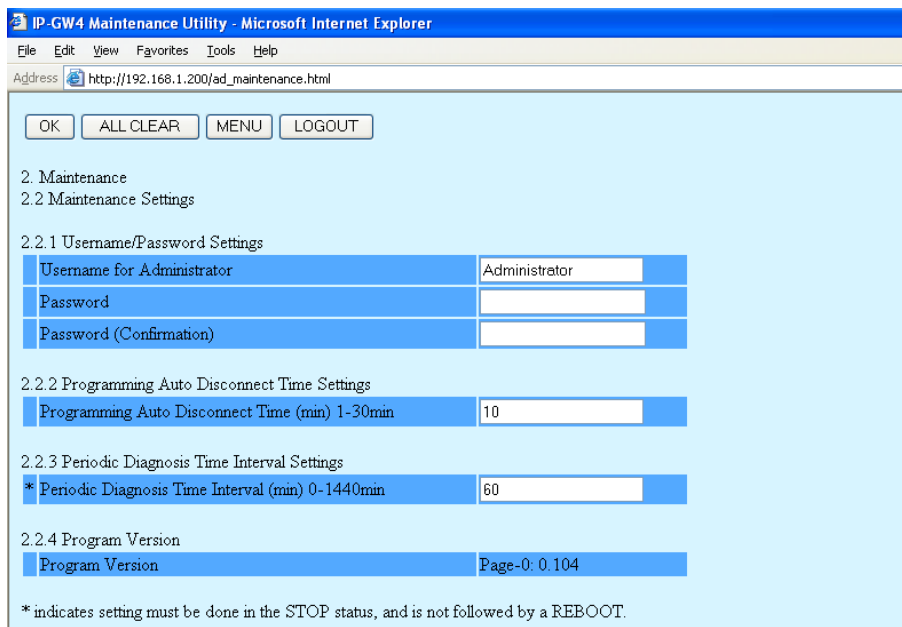

2. Assign each parameter referring to the descriptions below.

At any time during the session, you can:

- Click **ALL CLEAR** to return all parameters to their previous values.
- Click **MENU** to return to the main menu (see "2.1 Main Menu for the Administrator").
- Click **LOGOUT** to log out from the IP-GW4 Maintenance Utility (see "2.5.2 Log Out").

3. Click **OK**.

You will see a confirmation screen.

Note

If your entry contains an invalid value, you will be prompted to correct your input. Enter correct values for the parameters shown in red and try again.

4. Confirm your entry and click **OK**.

To return to the previous screen, click **CANCEL**.

Parameter Descriptions

The parameters indicated with "*" must be changed while the VoIP Gateway Card is in the "STOP" status (see "2.3.1 Status Control"). The changes do not have to be followed by a reboot to become effective.

Username/Password Settings

Parameter & Description	Default	Value Range
Username for Administrator Administrator-level log-in user name.	Administrator	Max. 16 characters
Password Administrator-level log-in password.	Administrator	Max. 16 characters

Parameter & Description	Default	Value Range
Password (Confirmation) Confirmation of the administrator-level log-in password.	No default	Max. 16 characters

Programming Auto Disconnect Time Settings

Parameter & Description	Default	Value Range
Programming Auto Disconnect Time (min) 1-30min Specifies the time (in minutes) until programming is automatically terminated. If the specified period of time passes with no programming input, programming will automatically be terminated. This prevents problems caused by continuation of log-in status in cases such as being unable to log out due to the sudden failure of a PC.	10	1 to 30

Periodic Diagnosis Time Interval Settings

Parameter & Description	Default	Value Range
* Periodic Diagnosis Time Interval (min) 0-1440min Specifies the time (in minutes) between periodic self-diagnoses to test operation as described in "2.3.3 Diagnosis". If failures are detected during the self-diagnosis, the card will alert the PBX.	60	0 (no periodic diagnosis), 1 to 1440

Program Version

Parameter	Default	Value Range
Program Version	Display only	

2.3.3 Diagnosis

This function is used to carry out the self-diagnostic program manually.

If failures are detected, there is a potential for trouble with the operation of the VoIP Gateway Card.

1. Click **2.3 Diagnosis** in the main menu.

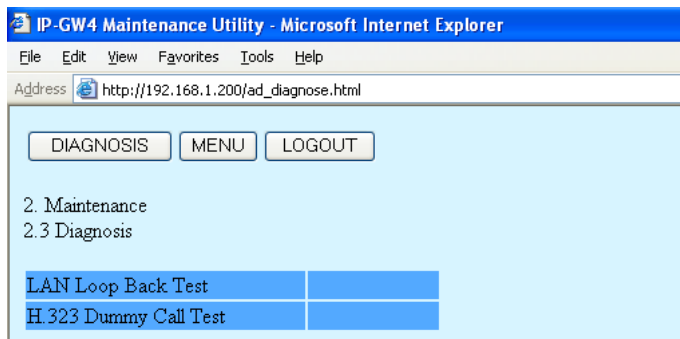

2. Click **DIAGNOSIS** to carry out the self-diagnostic program.

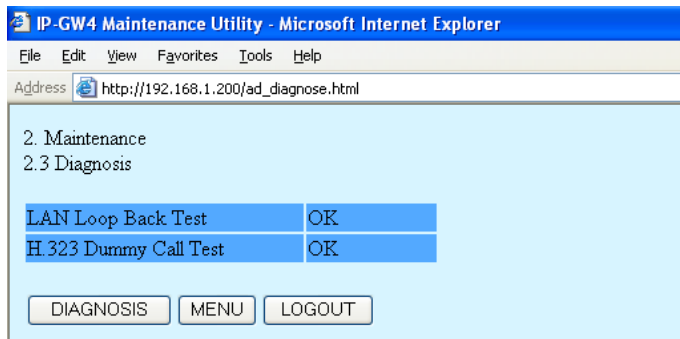

3. Do one of the following:

- Click **DIAGNOSIS** to carry out the self-diagnostic program again.
- Click **MENU** to return to the main menu (see "2.1 Main Menu for the Administrator").
- Click **LOGOUT** to log out from the IP-GW4 Maintenance Utility (see "2.5.2 Log Out").

2.3.4 Log Information

The function to collect log information is provided for engineer use only. However, in the case that a need should arise, this section provides the procedure for collecting the log information.

1. Click **2.4 Log Information** in the main menu.

The screenshot shows a web browser window titled "IP-GW4 Maintenance Utility - Microsoft Internet Explorer". The address bar shows "http://192.168.1.200/ad_log_option.html". The main content area displays the following configuration options:

Sort by Time/Date	<input checked="" type="radio"/> Ascending Order <input type="radio"/> Descending Order
Log Target	<input checked="" type="checkbox"/> Error Log <input checked="" type="checkbox"/> Call Log <input type="checkbox"/> Protocol Log
Error Log Filter	<input checked="" type="checkbox"/> Information <input checked="" type="checkbox"/> Minor Error <input checked="" type="checkbox"/> Major Error
Protocol Log Filter	<input type="checkbox"/> H.225.0 <input type="checkbox"/> H.245 <input type="checkbox"/> RAS <input type="checkbox"/> DPRAM <input type="checkbox"/> LAPD <input type="checkbox"/> QSIG <input type="checkbox"/> Others
Number of Log items	<input type="text" value="100"/>
Date Format	<input type="radio"/> MM-DD-YYYY <input checked="" type="radio"/> DD-MM-YYYY

At the bottom of the form are three buttons: **OK**, **MENU**, and **LOGOUT**.

2. Click **OK**.

Log information is displayed.

The screenshot shows the same web browser window, but the address bar now points to "http://192.168.1.200/ad_log_info.html". The main content area displays the following information:

2. Maintenance
2.4 Log Information (of interest to engineers only)

Date	Time	Type	Explanation
(Log entries would appear here)			

Below the table are two links: [Download \(All\)](#) and [Download \(Displayed portion only\)](#). At the bottom are four buttons: **UPDATE**, **LOG SETTING**, **MENU**, and **LOGOUT**.

3. Click **Download (All)** to download the log information.

2.4 Data Management

It is strongly recommended that you download the configuration data and the address translation table (DN2IP) data from the VoIP Gateway Card for backup and archive purposes.

The following sections provide the procedures for downloading and uploading.

2.4.1 Upload of Configuration Data

Before uploading the data, place the card in the "STOP" status (see "2.3.1 Status Control").

1. Click **3.1 Upload of Configuration data (PC → VoIP Gateway)** in the main menu.

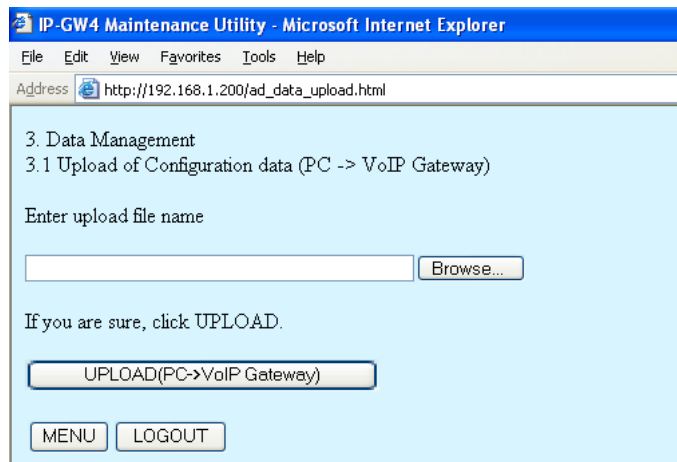

2. Click **Browse** and choose a file to upload.

At any time during the session, you can:

- Click **MENU** to return to the main menu (see "2.1 Main Menu for the Administrator").
- Click **LOGOUT** to log out from the IP-GW4 Maintenance Utility (see "2.5.2 Log Out").

3. Click **UPLOAD (PC→VoIP Gateway)**.

The upload operation starts.

Notes

- If the upload operation is executed while the card is in the "RUN" status, you will see an error screen. Click **Change RUN/STOP status Screen** and place the card in the "STOP" status (see "2.3.1 Status Control"), and then upload the data again.
- If the operation is not successful for other reasons, you will see another error screen. Click **OK** to return to the previous screen, and then upload the data again.

2.4 Data Management

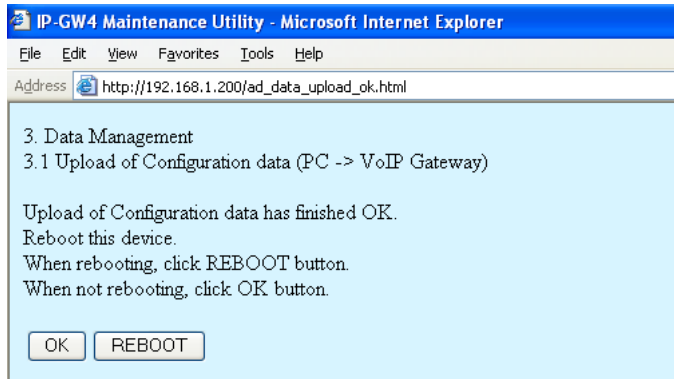

4. Do one of the following:

- Click **REBOOT** to make the changes effective now.
You will see a confirmation screen. Refer to "2.5.1 Reboot" and finish the reboot.
- Click **OK** to return to the previous screen without rebooting.
However, remember to reboot the card at the end of the programming session to make changes effective.

2.4.2 Download of Configuration Data

1. Click **3.2 Download of Configuration data (VoIP Gateway → PC)** in the main menu.

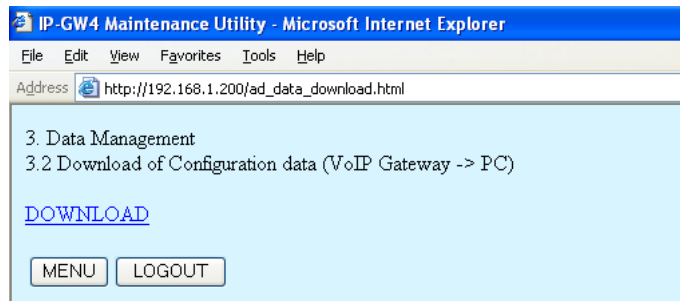

2. Click **DOWNLOAD**.

At any time during the session, you can:

- Click **MENU** to return to the main menu (see "2.1 Main Menu for the Administrator").
 - Click **LOGOUT** to log out from the IP-GW4 Maintenance Utility (see "2.5.2 Log Out").
3. Specify the file name and the folder in which to save the file.

2.4.3 Upload of Address Translation Table

Before uploading the data, place the card in the "STOP" status (see "2.3.1 Status Control").

1. Click **3.3 Upload of DN2IP data (PC → VoIP Gateway)** in the main menu.

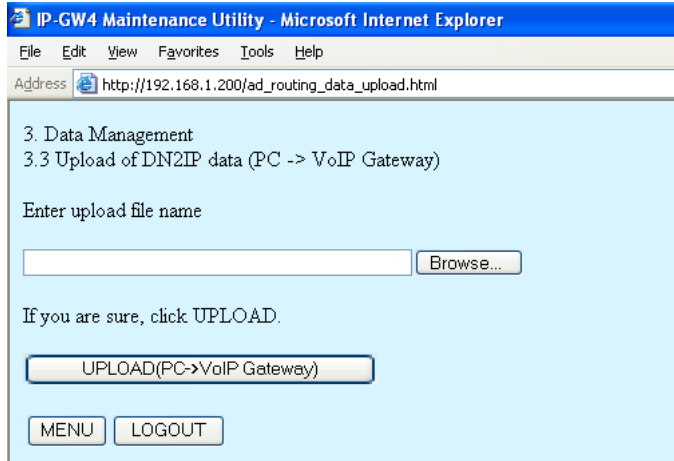

2. Click **Browse** and choose a file to upload.
At any time during the session, you can:
 - Click **MENU** to return to the main menu (see "2.1 Main Menu for the Administrator").
 - Click **LOGOUT** to log out from the IP-GW4 Maintenance Utility (see "2.5.2 Log Out").
3. Click **UPLOAD (PC→VoIP Gateway)**.
The upload operation starts.

Notes

- If the upload operation is executed while the card is in the "RUN" status, you will see an error screen. Click **Change RUN/STOP status Screen** and place the card in the "STOP" status (see "2.3.1 Status Control"), and then upload the data again.
- If the operation is not successful for other reasons, you will see another error screen. Click **OK** to return to the previous screen, and then upload the data again.

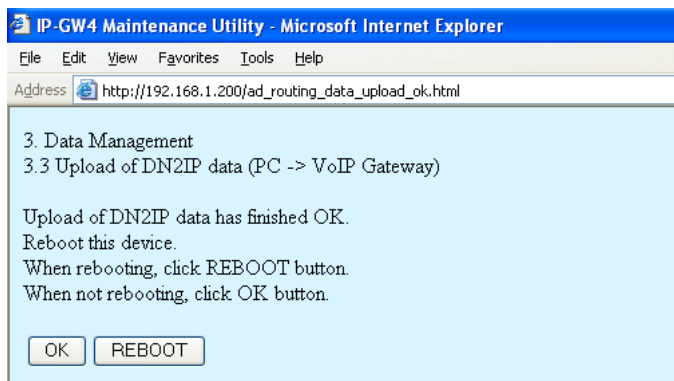

4. Do one of the following:
 - Click **REBOOT** to make the changes effective now.
You will see a confirmation screen. Refer to "2.5.1 Reboot" and finish the reboot.
 - Click **OK** to return to the previous screen without rebooting.

However, remember to reboot the card at the end of the programming session to make changes effective.

2.4.4 Download of Address Translation Table

1. Click **3.4 Download of DN2IP data (VoIP Gateway → PC)** in the main menu.

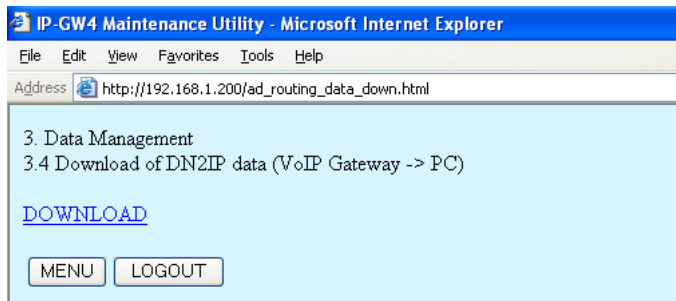

2. Click **DOWNLOAD**.

At any time during the session, you can:

- Click **MENU** to return to the main menu (see "2.1 Main Menu for the Administrator").
 - Click **LOGOUT** to log out from the IP-GW4 Maintenance Utility (see "2.5.2 Log Out").
3. Specify the file name and the folder in which to save the file.

2.5 Others

2.5.1 Reboot

1. Click **REBOOT** in the main menu.

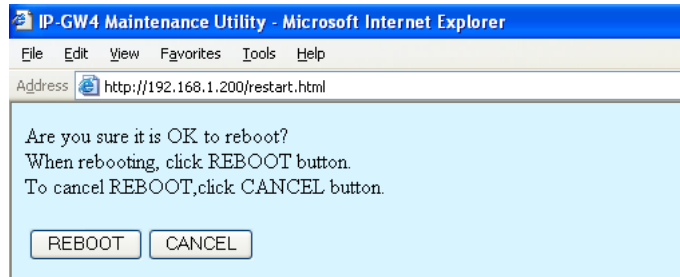

2. Click **REBOOT**.
To return to the main menu, click **CANCEL** (see "2.1 Main Menu for the Administrator").

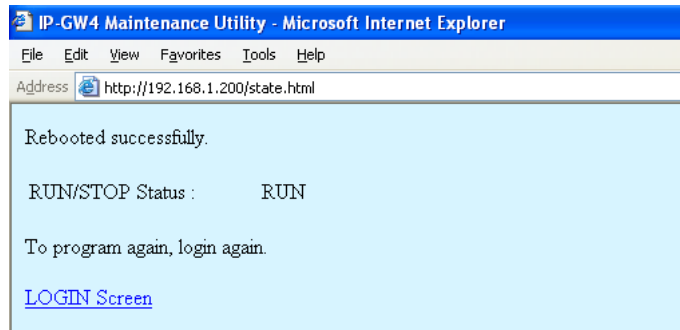

Note

If the reboot operation is not successful, you will see an error page.

3. To continue programming, click **LOGIN Screen** and log in again.
You will see the log-in screen (see "1.1 Starting the IP-GW4 Maintenance Utility").

2.5.2 Log Out

1. Click **LOGOUT** in the main menu.

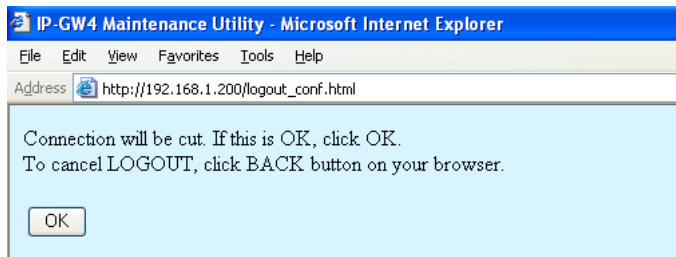

2. Click **OK** to log out.

Section 3

Installer Functions

This section provides operating instructions for the IP-GW4 Maintenance Utility when logged in as the Installer.

3.1 Main Menu for the Installer

The IP-GW4 Maintenance Utility provides the following menu to a user logged in as the Installer.

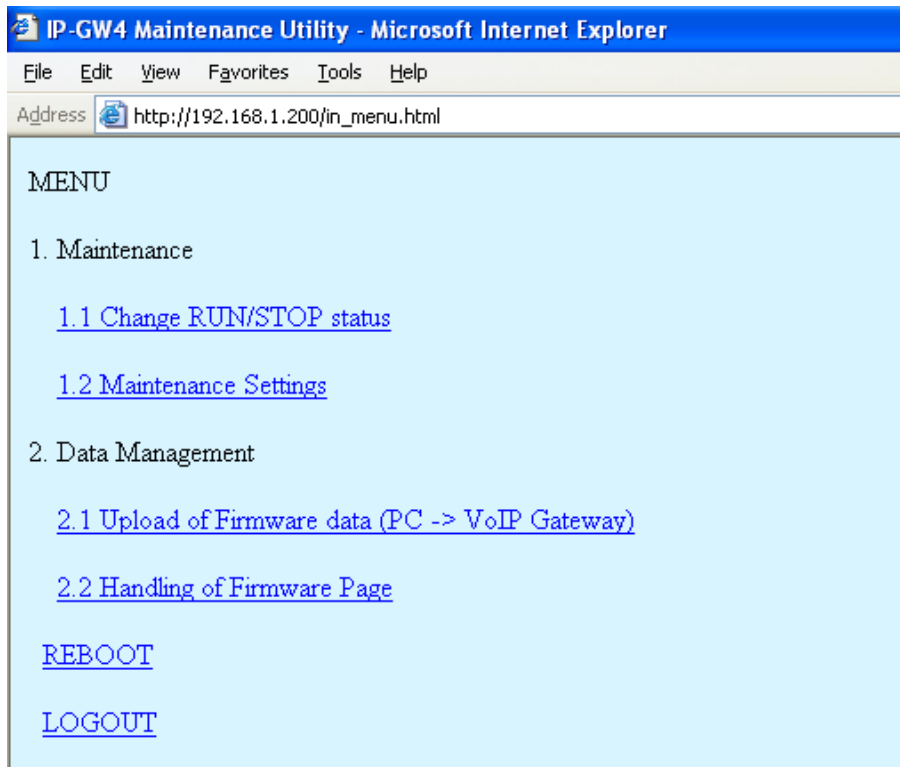

Maintenance

Menu	Section Reference
1.1 Change RUN/STOP status	3.2.1 Status Control
1.2 Maintenance Settings	3.2.2 Maintenance Settings

Data Management

Menu	Section Reference
2.1 Upload of Firmware data (PC → VoIP Gateway)	3.3.1 Upload of Firmware Data
2.2 Handling of Firmware Page	3.3.2 Handling of Firmware Page

Others

Menu	Section Reference
REBOOT	3.4.1 Reboot
LOGOUT	3.4.2 Log Out

3.2 Maintenance

3.2.1 Status Control

1. Click **1.1 Change RUN/STOP status** in the main menu.

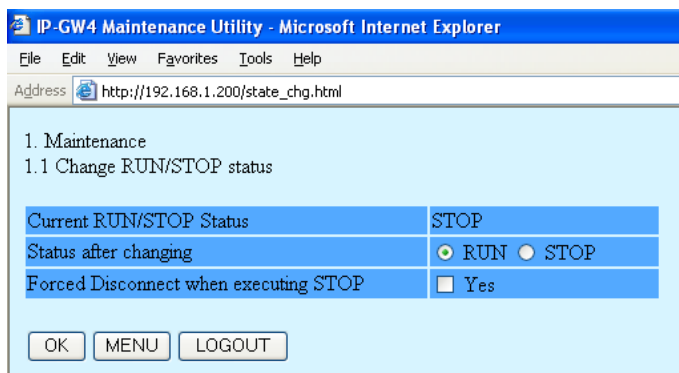

Current RUN/STOP Status shows the current status of the VoIP Gateway Card.

2. Click **RUN** or **STOP** for **Status after changing**.

If you want to forcibly change the status from "RUN" to "STOP" while there are ongoing calls, click the **Yes** check box for **Forced Disconnect when executing STOP**. This will allow you to place the card in the "STOP" status even when there are ongoing calls.

At any time during the session, you can:

- Click **MENU** to return to the main menu (see "3.1 Main Menu for the Installer").
- Click **LOGOUT** to log out from the IP-GW4 Maintenance Utility (see "3.4.2 Log Out").

3. Click **OK**.

You will see a confirmation screen.

4. Click **OK**.

You will see a result screen.

Note

If the operation is not successful, you will see an error screen. Click **OK** to return to the previous screen, and then try again.

5. Click **OK**.

You will be taken back to the **Change RUN/STOP status** screen.

3.2.2 Maintenance Settings

1. Click **1.2 Maintenance Settings** in the main menu.

2. Assign each parameter referring to the descriptions below.

At any time during the session, you can:

- Click **ALL CLEAR** to return all parameters to their previous values.
- Click **MENU** to return to the main menu (see "3.1 Main Menu for the Installer").
- Click **LOGOUT** to log out from the IP-GW4 Maintenance Utility (see "3.4.2 Log Out").

3. Click **OK**.

You will see a confirmation screen.

Note

If your entry contains an invalid value, you will be prompted to correct your input. Enter correct values for the parameters shown in red and try again.

4. Confirm your entry and click **OK**.

To return to the previous screen, click **CANCEL**.

Parameter Descriptions

Username/Password Settings

Parameter & Description	Default	Value Range
Username for Installer Installer-level log-in user name.	Installer	Max. 16 characters
Password Installer-level log-in password.	Installer	Max. 16 characters
Password (Confirmation) Confirmation of the installer-level log-in password.	No default	Max. 16 characters

Program Version

Parameter	Default	Value Range
Program Version	Display only	

3.3 Data Management

The upload and update operations of the firmware data are closely related. First follow the procedure as described in "3.3.1 Upload of Firmware Data" to upload new firmware data to the VoIP Gateway Card, and then go on to "3.3.2 Handling of Firmware Page" to update the card with the newly uploaded firmware data.

3.3.1 Upload of Firmware Data

Before uploading the data, place the card in the "STOP" status (see "3.2.1 Status Control").

1. Click **2.1 Upload of Firmware data (PC → VoIP Gateway)** in the main menu.

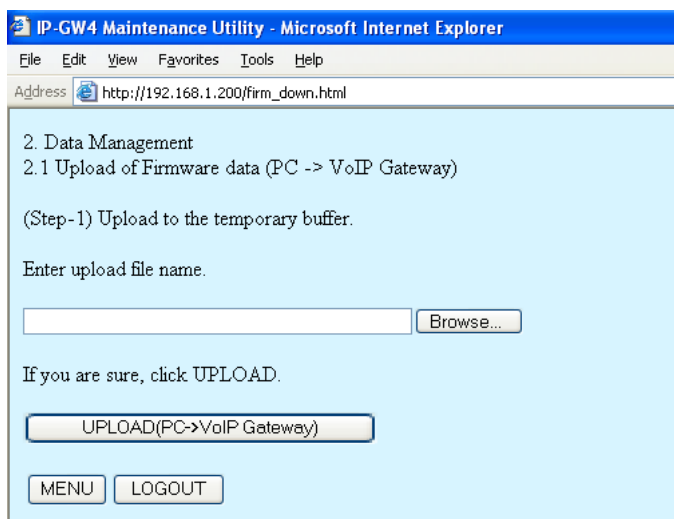

2. Do the following to upload the firmware data to the temporary buffer in the VoIP Gateway Card:
 - a. Click **Browse** and choose a file to upload.
At any time during the session, you can:
 - Click **MENU** to return to the main menu (see "3.1 Main Menu for the Installer").
 - Click **LOGOUT** to log out from the IP-GW4 Maintenance Utility (see "3.4.2 Log Out").
 - b. Click **UPLOAD (PC→VoIP Gateway)**.
The upload operation starts.

Note

If the upload operation is executed while the card is in the "RUN" status, you will see an error screen. Click **Change RUN/STOP status Screen** and place the card in the "STOP" status (see "3.2.1 Status Control"), and then upload the data again.

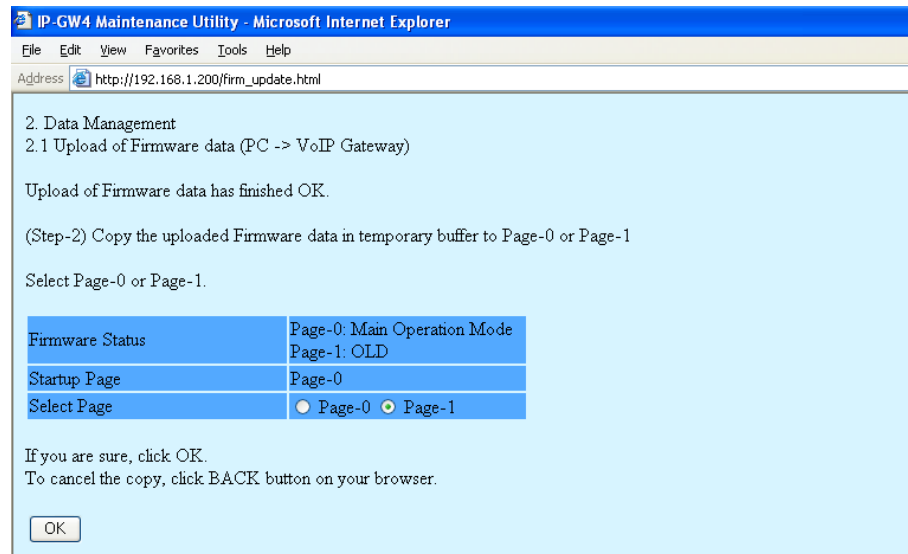

Firmware Status shows the current firmware status of page 0 and page 1, and **Startup Page** shows the current active page on startup. For details about these parameters, refer to "3.3.2 Handling of Firmware Page".

3. Do the following to update the desired page with the uploaded firmware data:
 - a. Click the option for the page whose current firmware status is not "Main Operation Mode" for **Select Page**.
 - b. Click **OK**.
You will see a confirmation screen.
 - c. Click **OK**.

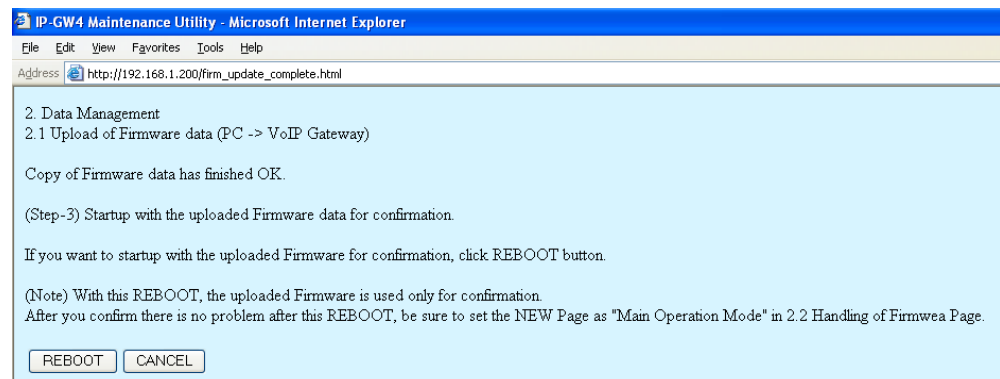

4. Do one of the following:
 - Click **REBOOT** to start up the VoIP Gateway Card with the updated page and confirm that the upload operation has been carried out successfully.
You will see a reboot confirmation screen. Refer to "3.4.1 Reboot" and finish the reboot.

Note

After the reboot, the card starts up with the updated page temporarily so that you can confirm the result of the upload operation. If you reboot again, the card does not start up with the updated page, but starts up with the page whose current firmware status is "Main Operation Mode".

- Click **CANCEL** to return to the main menu without starting up the card with the updated page.

5. Switch the firmware status of the updated page from "NEW" to "Main Operation Mode".
After the previous step (with or without a reboot), the firmware status of the updated page is still "NEW". To set the updated page as the active page on startup, you must change its firmware status to "Main Operation Mode". For instructions, refer to "3.3.2 Handling of Firmware Page".

The following is a sample image of the screen in which you can set the active page on startup:

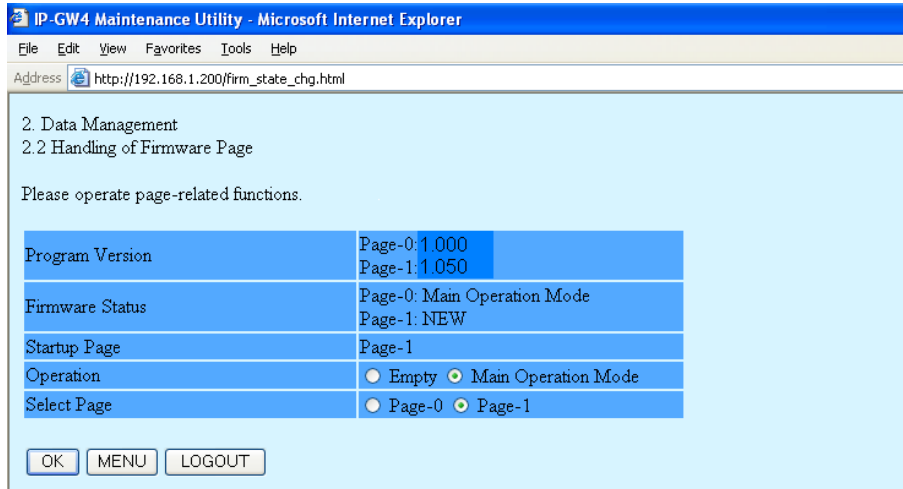

3.3.2 Handling of Firmware Page

1. Click **2.2 Handling of Firmware Page** in the main menu.

Program Version	Page-0: 1.000 Page-1: 1.050
Firmware Status	Page-0: Main Operation Mode Page-1: NEW
Startup Page	Page-1
Operation	<input type="radio"/> Empty <input checked="" type="radio"/> Main Operation Mode
Select Page	<input checked="" type="radio"/> Page-0 <input type="radio"/> Page-1

OK MENU LOGOUT

For details about the parameters on this screen, refer to the descriptions below.

2. Click **Main Operation Mode** for **Operation** to set the desired page as the active page on startup.

Note

Do not click **Empty**, as it is an option provided for engineer use only.

At any time during the session, you can:

- Click **MENU** to return to the main menu (see "3.1 Main Menu for the Installer").
- Click **LOGOUT** to log out from the IP-GW4 Maintenance Utility (see "3.4.2 Log Out").

3. Click the option for the page in the "NEW" status for **Select Page** to specify it as the target page of the operation.
4. Click **OK**.
You will see a confirmation screen.
5. Click **OK**.
You will see a result screen.
6. Click **OK**.
You will be taken back to the **Handling of Firmware Page** screen.

Parameter Descriptions

Parameter & Description	Default	Value Range
<p>Program Version</p> <p>Indicates the current version of the two firmware data in the VoIP Gateway Card: page 0 and page 1.</p>	Display only	

Parameter & Description	Default	Value Range
<p>Firmware Status</p> <p>Indicates the current firmware status of the corresponding page. There are 3 kinds of status indications:</p> <ul style="list-style-type: none"> • Main Operation Mode: Active firmware data on startup under normal operation. • OLD: Firmware data uploaded to the card before the firmware data in the "Main Operation Mode" status was uploaded. • NEW: Firmware data uploaded to the card after the firmware data in the "Main Operation Mode" status was uploaded. <p>Note</p> <p>The status indications "OLD" and "NEW" are irrelevant to the version of the firmware data.</p>	Display only	
<p>Startup Page</p> <p>Indicates the active page on startup. Generally, the startup page is the firmware data whose status is "Main Operation Mode".</p> <p>The exception is when the card undergoes a reboot after a firmware data upload operation; in this case, the card starts up with the page in the "NEW" status. This is for the purposes of confirming the result of the upload operation. If you reboot again, the card starts up with the page in the "Main Operation Mode" status.</p> <p>To set the updated page as the active page on startup, you must change its firmware status to "Main Operation Mode".</p>	Display only	
<p>Operation</p> <p>Specifies whether to set the page (selected with the parameter Select Page) as the active page on startup ("Main Operation Mode"), or delete the page ("Empty").</p> <p>"Empty" is an option provided for engineer use only.</p>	Not applicable	Empty, Main Operation Mode
<p>Select Page</p> <p>Specifies the target page of the operation selected with the parameter Operation.</p>	Not applicable	Page-0, Page-1

3.4 Others

3.4.1 Reboot

1. Click **REBOOT** in the main menu.

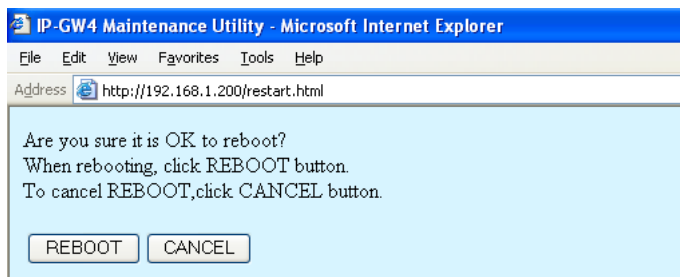

2. Click **REBOOT**.
To return to the main menu, click **CANCEL** (see "3.1 Main Menu for the Installer").

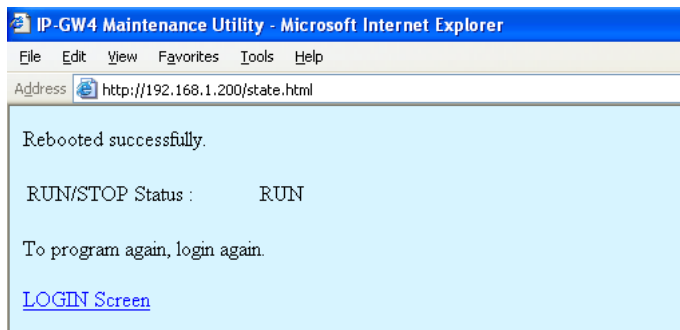

Note

If the reboot operation is not successful, you will see an error page.

3. To continue programming, click **LOGIN Screen** and log in again.
You will see the log-in screen (see "1.1 Starting the IP-GW4 Maintenance Utility").

3.4.2 Log Out

1. Click **LOGOUT** in the main menu.

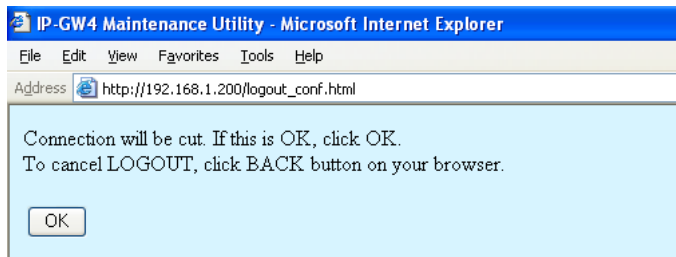

2. Click **OK** to log out.

Index

A

Automatic Route Redirection 37

B

Bandwidth 22, 24

C

Call Signaling Model 16
Change RUN/STOP status 40, 55
CODEC Frame Settings 20, 22

D

Default Gateway 11
DHCP Settings 11
Diagnosis 43
Dialing Settings 25
DiffServ 19
Digit End Code 26
DN2IP (Dialed Number to IP Address Translation) 32, 35
DN2IP Entry 35, 36
Download of Address Translation Table 50
Download of Configuration Data 47
DSCP 19, 22
DTMF Detection 20, 23
DTMF Detection Level 21
DTMF Relay 20, 23

E

Echo Cancellor 20
ECM (Error Correction Model) 23
Empty 62

F

Fast Connect 17
FAX High Reliable Method 21, 24
FAX Signal Detection 20, 23
Firmware Status 62
First Digit Time 25

G

G.168 20
G.711A 15
G.711Mu 15
G.723.1 15
G.723.1 Rate 20
G.723.1 VAD (Voice Activity Detection) 20
G.729A 15
Gatekeeper Settings 16
GW Entry 32, 33

H

H.225 Port No. 15
H.245 Port No. 15
H.323 14
H.323 Detailed Settings 14
Handling of Firmware Page 61
Host Name 12

HTTP Settings 12
Hunt Pattern (for Incoming Calls) 27

I

Initialization 39
Inter-Digit Time 26
IP Address 11
IP Address Settings 11
IP Header 19, 21

J

Jitter buffer Settings 19

L

LAN 22, 24
LAN Disconnect Threshold Time 12
Log Information 44
Log Out 52, 64

M

Main Menu for the Administrator 8
Main Menu for the Installer 54
Main Operation Mode 62
Maintenance Settings 41, 56

N

Network CODEC of IP-PBX 26
Network Settings, General 10

P

Packet Sending Interval 20, 22, 23, 24
Periodic Diagnosis Time Interval Settings 42
Port Number Settings 15
PPP (Point-to-Point Protocol) 23, 24
Program Version 42, 57, 61
Programming Auto Disconnect Time Settings 42

Q

QoS Field Settings 19, 21
QSIG Connectionless Tunneling Settings 12

R

RAS Port No. 15
Reboot 51, 63
RTP/RTCP Port No. 15

S

Startup Page 62
Subnet Mask 11
Super G3 Mode 24

T

ToS 19, 21

U

Upload of Address Translation Table 48

Upload of Configuration Data	45
Upload of Firmware Data	58
Username/Password Settings	41, 56

V

VAD (Voice Activity Detection)	20
Voice CODEC Settings	15
Voice Communication Detailed Settings	18
VoIP Gateway/IP-PBX Interface Settings	25

Panasonic Telephone Systems



See More
Panasonic Manuals



www.voicesonic.com
Phone 877-289-2829

Copyright:

This material is copyrighted by Panasonic Communications Co., Ltd., and may be reproduced for internal use only. All other reproduction, in whole or in part, is prohibited without the written consent of Panasonic Communications Co., Ltd.

© 2004 Panasonic Communications Co., Ltd. All Rights Reserved.

PSQX3125XA KK0104AH2015